

Project	Quantity	Item #
Model Specified:		CSI Section 11400

### Roll-In Refrigerator Models For 72" High Racks/Self-Contained



Model RRI332HUT-FHS

### One, Two & Three Section Models, 32" Deep



- 1-Section Solid Door Model
- 2-Section Solid Door Model
- 3-Section Solid Door Model

- RRI132HUT-FHS\*
- RRI232HUT-FHS\*
- RRI332HUT-FHS



- 1-Section Solid Door Model
- 2-Section Solid Door Model
- 3-Section Solid Door Model

- ARI132HUT-FHS\*
- ARI232HUT-FHS\*
- ARI332HUT-FHS

The R & A Series represent Traulsen's Top-of-the-Line product offering. The "H-Height" roll-in refrigerator models are all designed to offer convenient interior storage for 72" high racks. Each is supplied standard with such high quality features as easy to operate microprocessor controls, balanced refrigeration systems and stainless steel exteriors. Additionally, they offer the widest range of optional accessories to choose from, and can be specified for use with many different applications, including: Foodservice, Correctional, Institutional, Export, etc.

### Standard Product Features

- R-Series: Stainless Steel Exterior & Interior
- A-Series: Stainless Steel Exterior/Anodized Aluminum Interior
- INTELA-TRAUL<sup>®</sup> Microprocessor Control System
- Balanced, Self-Contained Refrigeration System Using R-134a
- Scroll Blower Type Evaporator Fan
- Biased Return Air Duct
- Full Length Stainless Steel Doors With Locks
- Self-Closing Doors With Stay Open Feature At 120 Degrees
- Guaranteed For Life Cam-Lift Hinges
- Guaranteed For Life Horizontal Work Flow Door Handle(s)
- Standard Door Hinging: 132H = Right, 232H = Left/Right, 332H = Left/Right/Right (other hings available)
- Automatically Activated Incandescent Lights
- Stainless Steel Breaker Caps
- Accommodates Roll-In Racks Up To 72" High (provided by others)
- Automatic Non-Electric Condensate Evaporator
- Magnetic Snap-In Door Gaskets
- Gasket Protecting Metal Door Liner
- Controllable Anti-Condensate Door Perimeter Heaters
- Thermostatic Expansion Valve Metering Device
- Stainless Steel One-Piece Louver Assembly
- Stainless Steel Interior Rack Guides & Threshold Ramp(s)
- 9' Cord & Plug Attached
- One Year Parts And Labor Warranty
- Two Year Control Warranty (parts and labor)
- Five Year Compressor Warranty

### Options & Accessories

- Stainless Steel Finished Back With Rear Louvers
- Re-Hinging Feature For Door(s)
- Wire Shelf Package For Roll-In Models (includes three wire shelves per section)
- Additional Wire Shelves For Above
- Stainless Steel Shelf Package For Roll-In Models (includes three stainless steel shelves per section)
- Additional Stainless Steel Shelves For Above
- Locking Hasps (padlocks supplied by others)
- Export 220/50/1 Voltage
- Kool Klad Exterior Laminate Decor
- Clear Glass Door(s) In Place Of One Or More Solid Door(s)
- Fluorescent Lights
- Remote Applications (see form TR35837 for more details)
- Remote For Use With 20°F Glycol System
- Recessed Installation
- Prison/Correctional Facilities Options
- Two Year Service/Labor Warranty Available



\* **Noted models are ENERGY STAR<sup>®</sup> listed. Please refer to [www.energystar.gov](http://www.energystar.gov) to view the most up-to-date product listing and performance data.**



Listed by Underwriters Laboratories Inc., to U.S. and Canadian safety standards and Listed by NSF International.

Approval: \_\_\_\_\_



**TRAULSEN**  
4401 BLUE MOUND RD.  
PHONE 1 (800) 825-8220  
Website: [www.traulsen.com](http://www.traulsen.com)

FT. WORTH, TX 76106  
FAX-MKTG. 1 (817) 624-4302

Project	Quantity	Item #
Model Specified:		CSI Section 11400

## Specifications

### Construction, Hardware and Insulation

Cabinet exterior front, one piece sides, louver assembly and doors are constructed of 20 gauge stainless steel with #4 finish. Cabinet interior and door liners are constructed of stainless steel (anodized aluminum in the A-Series). The exterior cabinet top, back and bottom are constructed of heavy gauge aluminized steel. The interior floor is constructed of stainless steel and insulated with ¾" of resilient cork. A readily attachable stainless steel ramp is provided to facilitate loading/unloading.

Doors are equipped with a heavy-duty, extruded wiper gasket for sealing to bottom ramp, removable plug cylinder locks and guaranteed for life cam-lift, gravity action, self-closing metal, glide hinges with stay open feature at 120 degrees. Hinges include a concealed switch to automatically activate the interior incandescent lighting. Guaranteed for life, work flow door handles are mounted horizontally over recess in door which limits protrusion from door face into aiseways. Doors have seamless, polished metal corners.

Easily removable for cleaning, vinyl magnetic door gasket assures tight door seal.

Both the cabinet and door(s) are insulated with an average of 2" thick high density, non-CFC, foamed in place polyurethane.

DIMENSIONAL DATA	R/ARI132HUT	R/ARI232HUT	R/ARI332HUT
Net capacity cu. ft.	39.0 (1104 cu l)	79.5 (2252 cu l)	120.5 (3414 cu l)
Length - overall in.	35½ (90.2 cm)	68 (172.7 cm)	100½ (255.3 cm)
Depth - overall in.	35⅞ (90.3 cm)	35⅞ (90.3 cm)	35⅞ (90.3 cm)
Depth - over body in.	32 (81.3 cm)	32 (81.3 cm)	32 (81.3 cm)
Depth - door open 90° in.	63¼ (160.7 cm)	63¼ (160.7 cm)	63¼ (160.7 cm)
Clear door width in.	27⅞ (68.8 cm)	27⅞ (68.8 cm)	27⅞ (68.8 cm)
Clear door height in.	72⅞ (183.4 cm)	72⅞ (183.4 cm)	72⅞ (183.4 cm)
Height - overall in.	89⅞ (226.4 cm)	89⅞ (226.4 cm)	89⅞ (226.4 cm)
RRI Net Wt. lbs.	480 (218 kg)	785 (356 kg)	1075 (488 kg)
ARI Net Wt. lbs.	410 (186 kg)	685 (311 kg)	1000 (454 kg)
Rack Capacity - 72" High	1	2	3
ELECTRICAL DATA			
Voltage	115/60/1	115/60/1	115/60/1
Feed wires with Ground	3	3	3
Full load amperes	10.6	11.4	12.8
REFRIGERATION DATA			
Refrigerant	R-134a	R-134a	R-134a
BTU/HR H.P. <sup>1</sup>	2220 (½ HP)	4200 (½ HP)	5120 (¾ HP)

### NOTES

NOTE: Figures in parentheses reflect metric equivalents.

1= Based on a 90 degree F ambient and 20 degree F evaporator.

2= For approximate remote weights deduct 40 lbs. from respective net or gross weight. For other information on remote models, please refer to form TR35837.



**One & Two Section Models Equipped With One NEMA 5-15P Plug**



**Three Section Models Equipped With One NEMA 5-20P Plug**

NOTE: Full load amps and plug style may vary depending on electrical options chosen and condensing unit employed.

### REQUIRED CLEARANCES

In order to assure optimum performance, the condensing unit MUST have an adequate supply of air for cooling purposes. Therefore, the operating location must either have a minimum of 12" clearance overhead of the condensing unit or allow for unrestricted air flow at the back of the unit. Clearance of at least 12" above is required in order to perform certain maintenance tasks.

**NOTE: When ordering please specify: Voltage, Hinging, Door Size, Options and any additional warranties.**

Continued product development may necessitate specification changes without notice.  
Part No. TR35768 (revised 12/10)

### Refrigeration System

A top mounted, self-contained, balanced refrigeration system using R-134a refrigerant is conveniently located behind the one piece louver assembly. It features an easy to clean front facing condenser, thermostatic expansion valve, air-cooled hermetic compressor, plenum effect blower coil, large, high humidity evaporator coil located outside the food zone and a top mounted non-electric condensate evaporator. Biased return air duct protects against introduction of warm kitchen air, promoting even temperature maintenance and efficient operation. A 9' cord and plug is provided. Standard operating temperature is 34 to 38°F.

### Controller

The easy to use water resistant INTELA-TRAUL® microprocessor control system is supplied standard. Unit is NAFEM Data Protocol communication (NDP) ready. Optional hardware required to be NDP compliant. Third party software required for network connection. It includes a 3-Digit LED Display, Fahrenheit or Celsius Temperature Scale Display Capability, and an RS485 data port. In addition it includes audio/visual alarms for: Hi/Lo Cabinet Temperature, Door Open, Clean Condenser, Evaporator Coil and Discharge Line Sensor Failures, and Power Supply Interruption.

### Interior

Readily removable, interior-mounted, stainless steel guides for rack are provided for protection. Maximum rack size with wheels inboard of frame is 27" wide by 29" deep by 72" high. Racks supplied by others.

### Warranties

Both a one year parts and labor warranty and a five year compressor warranty (self-contained models only) are provided standard. An optional 2<sup>nd</sup> year extended parts and labor warranty is also available. In addition the INTELA-TRAUL® control is warranted by a two year parts and labor warranty.

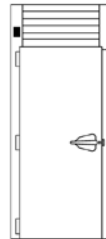

Elevation - R/ARI132HUT

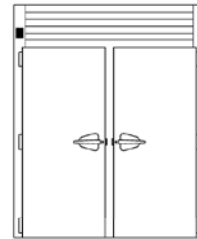

Elevation - R/ARI232HUT

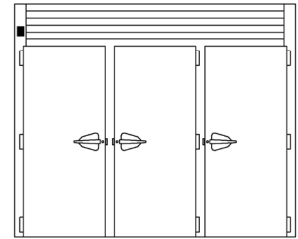

Elevation - R/ARI332HUT

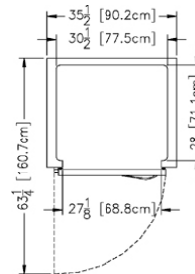

Plan - R/ARI132HUT

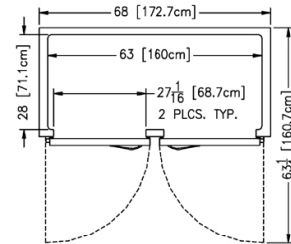

Plan - R/ARI232HUT

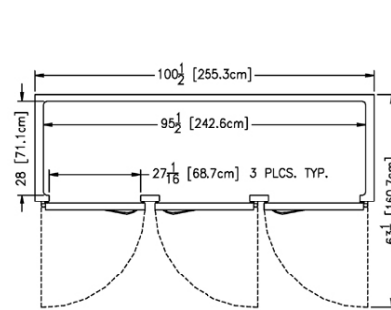

Plan - R/ARI332HUT

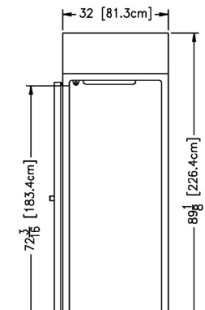

Section - All Models

**TRAULSEN**  
4401 BLUE MOUND RD.  
PHONE 1 (800) 825-8220  
Website: www.traulsen.com

FT. WORTH, TX 76106  
FAX-MKTG. 1 (817) 624-4302