

## Prodig<sup>TM</sup> Classic Control

6-10E Classic	6-10G Classic
10-10E Classic	10-10G Classic
7-20E Classic	7-20G Classic
10-20E Classic	10-20G Classic
20-10E Classic	20-10G Classic
20-20E Classic	20-20G Classic



**MN-47966-EN**

REV.07  
02/26

**EN**

For the most current manual, visit [alto-shaam.com](http://alto-shaam.com)  
Die neueste Fassung des Handbuchs finden Sie auf [alto-shaam.com](http://alto-shaam.com)  
Pour la dernière version du manuel, visitez [alto-shaam.com](http://alto-shaam.com)  
Para obtener el manual más actual, visite [alto-shaam.com](http://alto-shaam.com)  
Ga voor de meest recente handleiding naar [alto-shaam.com](http://alto-shaam.com)



# Manufacturer's Information

---

## Copyright

© Copyright 2/26 by Alto-Shaam, Inc.

All rights reserved.

This manual or any portion thereof may not be reproduced or used in any manner whatsoever without the express written permission of Alto-Shaam, Inc.

---

## Trademarks

All trademarks referenced in this documentation are the property of their respective owners.

---

## Manufacturer

Alto-Shaam, Inc.

P.O. Box 450

W164 N9221 Water Street

Menomonee Falls, WI 53052

---

## Original instructions

The content in this manual is written in American English.

---

## Software and manual updates

The information in this manual was current at the time of production. See [www.alto-shaam.com](http://www.alto-shaam.com) for the latest software and manual.



**DANGER:** Before starting the oven, make sure you do not detect the odor of gas.

If you smell gas:

- Shut off the gas supply immediately.
- Do not attempt to light any appliance.
- Do not touch any electrical elements.
- Extinguish any open flame.
- Evacuate the area.
- Use a telephone outside of the property and immediately contact your gas supplier.
- If unable to contact your supplier, contact the fire department.

## Enjoy your Alto-Shaam Prodigi™ Oven!

---

The Alto-Shaam Prodigi oven combines a steam and convection oven into one versatile unit and can serve a variety of cooking functions. Alto-Shaam's Prodigi ovens allow chefs to control humidity and temperature separately, with powerful results. The same oven can be used to dehydrate vegetables, roast pork, steam rice, smoke brisket and bake loaves of bread. The recipe management system with one-touch cooking provides complete control over the oven, allowing chefs and foodservice employees to select pre-programmed recipes for maximum consistency. To store and secure important information, a HACCP data system pairs up with an onboard USB port, so settings can be downloaded and saved for the future. When it's time to clean up, Alto-Shaam's automated cleaning system saves labor previously spent scrubbing the oven cavity. On the oven's exterior, a retractable hose gives you spray-washing power without opening the oven door.

## Extend Your Manufacturer's Warranty

---

### Register

Register your Alto-Shaam appliance online. Registering your appliance ensures prompt service in the event of a warranty claim.

Your personal information will not be shared with any other company.

[alto-shaam.com/warranty](http://alto-shaam.com/warranty)

## Alto-Shaam 24/7 Emergency Repair Service

---

### Call

Call 800-558-8744 to reach our 24-hour emergency service call center for immediate access to local authorized service agencies outside standard business hours. The emergency service access is provided exclusively for Alto-Shaam equipment and is available throughout the United States through Alto-Shaam's toll free number.

### Availability

Emergency service access is available seven days a week, including holidays.

This page is intentionally left blank.

Manufacturer’s Information . . . . . 2

**Foreword** . . . . . 3

    Enjoy your Alto-Shaam Prodigi™ Oven! . . . . . 3

    Extend Your Manufacturer’s Warranty . . . . . 3

    Alto-Shaam 24/7 Emergency Repair Service . . . . . 3

**Table of Contents** . . . . . 5

**Safety** . . . . . 7

    The Meaning of Signal Words . . . . . 7

    Appliance Description and Intended Use. . . . . 8

    Safety Precautions. . . . . 9

**Labels** . . . . . 13

    Labels. . . . . 13

**Operation** . . . . . 21

    How to Turn On and Turn Off the Oven . . . . . 21

    How to Preheat the Oven. . . . . 22

    How to Cook with Programmed Recipes . . . . . 23

    How to Cook in Professional Mode . . . . . 25

    How to Use the Multiple Shelf Timers. . . . . 29

    How to Lock and Unlock the Screen. . . . . 33

    How to Cool Down the Oven. . . . . 34

    How to Create a Recipe. . . . . 37

    How to Modify or Delete a Recipe. . . . . 42

    How to Backup or Restore Settings with a USB Drive. . . . . 44

    How to Backup Recipes to a USB Drive . . . . . 47

    How to Restore Recipes from a USB Drive . . . . . 50

    How to Update Software with a USB Drive. . . . . 53

    How to Temporarily Change Languages . . . . . 57

    How to Temporarily Change Temperature Units . . . . . 58

    How to Change the Home Screen. . . . . 59

    How to Change the Temperature Scale. . . . . 61

    How to Enable/Disable Automatic Preheat. . . . . 63

    How to Change the Cooking Complete Notification Sound . . . . . 65

    How to Lock Recipe Editing, the Settings  
    Screen, or Auto Screen Lock . . . . . 67

    How to View Oven Information . . . . . 69

    How to Download HACCP Data . . . . . 70

    How to Calibrate the Temperature Probe . . . . . 72

**Maintenance** . . . . . 75

    Maintenance Schedule . . . . . 75

    How to Clean the Oven using Cleaning Tablets . . . . . 77

# TABLE OF CONTENTS

How to Descale the Oven . . . . .	81
How to View the Cleaning Log . . . . .	85
How to Set the Cleaning Frequency . . . . .	87
How to Winterize the Oven . . . . .	90
<b>Troubleshooting</b>	<b>91</b>
Error Codes . . . . .	91
<b>Warranty</b>	<b>97</b>
Warranty . . . . .	97
<b>Declaration of Conformity</b>	<b>99</b>

# The Meaning of Signal Words

This manual contains signal words where needed. These signal words must be obeyed to reduce the risk of death, personal injury, or equipment damage. The meaning of these signal words is explained below.

**DANGER**

Danger indicates a hazardous situation which, if not avoided, will result in serious injury or death.

**WARNING**

Warning indicates a hazardous situation which, if not avoided, could result in serious injury or death.

**CAUTION**

Caution indicates a hazardous situation which, if not avoided, could result in minor or moderate injury.

**NOTICE**

Notice indicates a situation which, if not avoided, could result in property damage.



**NOTE:** Note indicates additional information that is important to a concept or procedure.

# Appliance Description and Intended Use

---

**Appliance description**

Engineered for dependability, connectivity, and cost savings, Prodigy™ combination ovens are an all-in-one solution for efficient and consistent food production. These ovens do the work of a convection oven, kettle, steamer, fryer, smoker and more. With advanced features and accessories, Prodigy combination ovens are designed to support—and connect—the most demanding kitchens.

---

**Intended use**

The appliance is intended for use in commercial establishments where all operators are familiar with the purpose, limitations, and associated hazards of this appliance. Any other use is prohibited. This appliance is intended to be used for commercial applications, for example in kitchens of restaurants, canteens, hospitals and in commercial enterprises such as bakeries, butcheries, etc., but not for continuous mass production of food.

---

**Residual risks**

This oven is manufactured using ISO-certified processes. The oven is designed with maximum safety in mind; however, there are residual risks to operators of this oven. Residual risks include exposure to heat and exposure to hot food products.

---

**Possible misuse**

Misuse of this oven includes loading the oven with anything other than a food product. Misuse also includes heating or cooking any food product that contains alcohol or other flammable substance.

# Safety Precautions

---

## Before you begin

Read and understand all instructions in this manual.

---

## Electrical precautions

Obey these electrical precautions when using the appliance:

- All electrical connections must be made by a qualified and trained service technician in accordance with applicable electrical codes.
  - Consult local codes and Specification Sheets for the electrical cable and breaker size.
  - Power source must match voltage identified on appliance tag.
  - CE-approved appliances include an equipotential-bonding terminal marked with the equipotential symbol.
  - For CE models, use a Type B current protection device that accommodates a leakage current of 30mA.
- 

## Gas precautions

Obey these gas precautions when using the appliance:

- Only use the oven when the exhaust hood is turned on.
  - Keep the area around the oven clear of any obstructions that might slow down the flow of cooling air.
  - Do not place objects near the oven's exhaust vents.
  - Do not touch the exhaust vents while the oven is running or immediately after it has been turned off.
  - Do not spray aerosols in the area of the oven during operation.
  - Do not store flammable materials in the area of the oven.
- 

## Usage precautions

Obey these usage precautions when using the appliance:

- Only use this appliance for its intended use of heating or cooking food.
- Always keep liquids, or foods that can become liquid when heated, level and at or below eye level where they can be seen.
- Always open the oven door slowly. Escaping hot vapors or steam can cause injury.
- Use utensils and protective clothing such as dry oven mitts when loading and unloading the appliance.
- Use caution when using the appliance. Floors adjacent to the appliance may become slippery.
- If the appliance is installed on casters, freedom of movement of the appliance must be restricted so that utility connections (including gas, water, and electricity) cannot be damaged when the appliance is moved. If the appliance is moved, make sure that all utility connections are properly disconnected. If the appliance is returned to its original position, make sure that any retention devices and utility connections are properly connected.

*Continued on next page*

*Continued from previous page*

- Do not cover or block any of the openings of this appliance.
- Do not cover racks or any other part of this appliance with metal foil.
- Do not keep anything underneath the oven that could block the vents.
- Do not use this appliance near water such as a sink, in a wet location, near a swimming pool, or similar locations.

## Maintenance precautions

Obey these maintenance precautions when maintaining the appliance:

- Obey precautions in the manual, on tags, and on labels attached to or shipped with the appliance.
- Only clean the exterior of the appliance when oven is OFF.
- Do not store the appliance outdoors.
- Do not clean the appliance with metal scouring pads.
- Do not use corrosive chemicals when cleaning the appliance.
- Do not use a hose, water jet, or steam cleaner to clean the appliance.
- Do not use the appliance cavity for storage.
- Do not leave flammable materials, cooking utensils, or food inside the appliance when it is not in use.
- Do not remove the top cover or side panels. There are no user-serviceable components inside.

## Operator training

Before using the appliance:

- Read and understand the operating instructions contained in all the documentation delivered with the appliance.
- Know the location and proper use of all controls.
- Keep this manual and all supplied instructions, diagrams, schematics, parts lists, notices, and labels with the appliance if the appliance is sold or moved to another location.
- Contact Alto-Shaam for additional training if needed.

## Operator qualifications

Only trained personnel are permitted to use the appliance. They must meet the following qualifications:

- Have received proper instruction on how to use the appliance
- Are familiar with commercial kitchens and commercial appliances

The appliance must not be used by:

- Persons (including children) with reduced physical, sensory or mental capabilities, or lack of experience and knowledge, unless they have been given supervision concerning use of the appliance by person responsible for their safety.
- People impaired by drugs or alcohol.

*Continued on next page*

*Continued from previous page*

- Children should be supervised to ensure that they do not play with the appliance.
  - Children shall neither clean nor maintain the appliance.
- 

### **Condition of appliance**

Only use the appliance when:

- All controls operate correctly
  - The appliance is installed correctly
  - The appliance is clean
  - The appliance labels are legible
- 

### **Servicing the appliance**

- Only trained personnel are permitted to service or repair the appliance. Repairs that are not performed by an authorized service partner or trained technician, or the use of non-factory parts, will void the warranty and relieve Alto-Shaam of all liability.
  - To prevent serious injury, death or property damage, have the appliance inspected and serviced at least every twelve (12) months by an authorized service partner or trained technician.
  - Contact Alto-Shaam for the authorized service partner in your area.
- 

### **Noise emissions**

- Without hood system, a maximum 67 dB(A) was measured at 3.3 ft (1m) from unit.
  - With hood system, a maximum 73 dB(A) was measured at 3.3 ft (1m) from unit.
- 

### **Massachusetts compliance**

In accordance with NFPA 54 for the Commonwealth of Massachusetts only: Where automatically operated appliances are vented through a ventilation hood or exhaust system equipped with a damper or with a power means of exhaust, provisions shall be made to allow the flow of gas to the main burners only when the damper is open to a position to properly vent the appliance and when the power means of exhaust is in operation.

---

### **Personal Protective Equipment (PPE)**

Wear the following Personal Protective Equipment (PPE) while cleaning the appliance:

- Protective gloves
  - Protective clothing
  - Eye protection
  - Face protection
- 

*Continued on next page*

Continued from previous page



**DANGER:** Before starting the oven, make sure you do not detect the odor of gas.

If you smell gas:

- Shut off the gas supply immediately.
- Do not attempt to light any appliance.
- Do not touch any electrical elements.
- Extinguish any open flame.
- Evacuate the area.
- Use a telephone outside of the property and immediately contact your gas supplier.
- If unable to contact your supplier, contact the fire department.

**NOTICE**



For equipment delivered for use in any location regulated by the following directive:  
2012/19/EU WEEE

Do not dispose of electrical or electronic equipment with other municipal waste.

# Labels

	<p>Made in U.S.A.</p>
	<p>WARNING Hot surface</p>
	<p>WARNING Electrical shock hazard</p>
	<p>Security seal</p>
	<p>WARNING Burn hazard Always load liquids, or foods that can become liquid when heated, at an eye level where they can be seen.</p>
	<p>Every Alto-Shaam product is precision calibrated prior to release from the factory to ensure accurate temperature control.</p>
 <p>LA-36443-E</p>	<p>Equipotential terminal</p>

LABELS



Drain water connection point.



Untreated, drinkable water connection point.

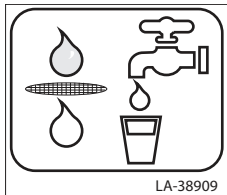

Treated, drinkable water connection point.

	Σ kg max.	Σ liter max.	Σ GN 1/1
6-10	33	57	7
10-10	54	95	11
7-20	76	133	16
10-20	109	190	22
20-10	109	190	20
20-20	218	380	40

LA-48238

Capacities

**WARNING/ADVERTENCIA/AVERTISSEMENT**

**Fire Hazard**  
This appliance is only for use with factory-supplied legs, casters, or base.

**Peligro de incendio**  
Este aparato solo se puede usar con patas, ruedas o base proporcionadas por la fábrica.

**Risque d'incendie**  
Ce appareil est destiné à être utilisé uniquement avec les pieds, les roulettes ou le socle fournis par le fabricant.

LA-39338

WARNING

Fire hazard

This oven is only for use with factory-supplied legs, casters, or base.

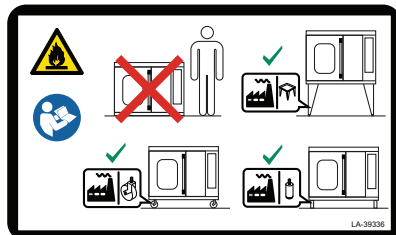



WARNING

Steam. Open door carefully.

**WARNING  
ADVERTENCIA  
AVERTISSEMENT**

Failure to follow cleaning instructions can cause injury or equipment damage. Clean oven only with Alto-Shaam concentrated cleaning tablets. Cleaner is caustic. Avoid contact with skin or eyes. Wear PPE. Read and understand the safety data sheet and the operator's manual before cleaning.

Si no se siguen las instrucciones de limpieza, puede sufrir lesiones o daños en el equipo. Limpie el horno solo con las pastillas de limpieza concentradas de Alto-Shaam. El limpiador es cáustico. Evite el contacto con la piel o los ojos. Use equipo de protección personal (Personal Protective Equipment, PPE). Lea completamente la hoja de datos de seguridad y el manual del operador antes de realizar la limpieza.

Pour écarter les risques de blessures ou de dégâts matériels, veiller à respecter les instructions de nettoyage. Nettoyer le four uniquement avec les pastilles nettoyantes concentrées Alto-Shaam. Le produit nettoyant est caustique. Éviter le contact avec la peau et les yeux. Porter un EPI. Lire et comprendre la fiche de données de sécurité et le manuel de l'utilisateur avant de nettoyer.

LA-22836

WARNING

Failure to follow cleaning instructions can cause injury or equipment damage. Clean oven only with Alto-Shaam concentrated cleaning tablets. Cleaner is caustic. Avoid contact with skin or eyes. Wear PPE. Read and understand the safety data sheet and the operator's manual before cleaning.

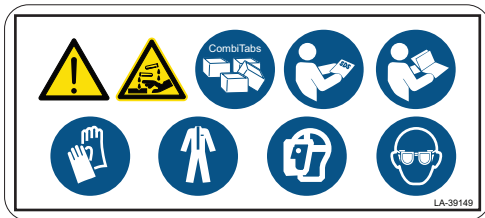

**WARNING/ADVERTENCIA/AVERTISSEMENT**

**Electric Shock Hazard**  
Appliances with permanent electrical connection that are mounted on casters must be secured to building structure. Read installation instructions.

**Peligro de descarga eléctrica**  
Los equipos con una conexión eléctrica permanente que estén montados sobre ruedas deben estar fijos a la estructura del edificio. Lea las instrucciones de instalación.

**Risque d'électrocution**  
Les appareils à branchement électrique fixe qui sont montés sur roulettes doivent être attachés à la structure du bâtiment. Lire les instructions d'installation.

LA-38912

WARNING

Electric shock hazard

Appliances with permanent electrical connections that are mounted on casters must be secured to building structure. Read installation instructions.

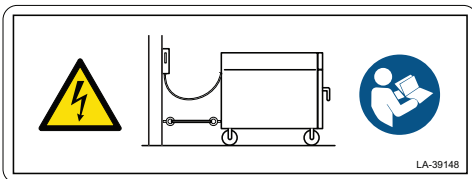

**WARNING/ADVERTENCIA/AVERTISSEMENT**

**WARNING:**  
Improper installation, adjustment, alteration, service or maintenance can cause property damage, injury or death. Read the installation, operating and maintenance instructions thoroughly before installing or servicing the equipment.

Water and waste connection shall comply with the basic plumbing code of the Building Officials and Code Administrators International, Inc. (BOCA) and the Food Service Sanitation Manual of the Food and Drug Administration (FDA).

**ADVERTENCIA:**  
Una instalación, ajuste, modificación, reparación o mantenimiento inadecuado podría producir daños en el equipo, lesiones personales e incluso la muerte. Lea las instrucciones de instalación, funcionamiento y mantenimiento detenidamente antes de instalar o reparar el equipo.

La conexión de agua y de aguas residuales debe cumplir el Código de Tuberías Básico (Basic Plumbing Code) de Building Officials and Code Administrators International, Inc. (BOCA), y el Manual de Sanidad de Servicio de Alimentos (Food Service Sanitation Manual) de la Administración de Drogas y Alimentos (FDA, por sus siglas en inglés).

**AVERTISSEMENT:**  
L'installation, le réglage, la modification, la réparation ou l'entretien incorrect de cet appareil peut causer des dommages matériels, des blessures ou la mort. Lire attentivement les instructions d'installation, de fonctionnement et d'entretien avant de procéder à son installation ou entretien.

Le raccordement d'eau et d'évacuation doit être conforme au Basic Plumbing Code de BOCA (Building Officials and Code Administrators International, Inc.) et au Food Service Sanitation Manual de la FDA (Food and Drug Administration).

LA-38905

WARNING

Improper installation, adjustment, alteration, service or maintenance can cause property damage, injury or death. Read the installation, operating and maintenance instructions thoroughly before installing or servicing the equipment. Water and waste connection shall comply with the basic plumbing code of the Building Officials and Code Administrators International, Inc. (COCA) and the Food Service Sanitation Manual of the Food and Drug Administration (FDA).

**WARNING/ADVERTENCIA/AVERTISSEMENT**

**Fire Hazard**  
For use only on noncombustible surfaces. Maintain the correct clearances to combustibles.

**Peligro de incendio**  
Solo para uso en superficies no combustibles. Mantenga las distancias correctas de elementos combustibles.

**Risque d'incendie**  
Utilisation sur des surfaces non combustibles seulement. Maintenir des dégagements corrects par rapport aux matières combustibles.

	Combustibles	Non-combustibles
Top/tepe/haut	20" (508mm)	20" (508mm)
Left/izquierda/gauche	0" (0mm)	0" (0mm)
Right/derecho/droite	2" (51mm)	0" (0mm)
Rear/posterior/arrière	4" (102mm)	4" (102mm)

LA-38906

WARNING

Fire hazard

For use only on noncombustible surfaces. Maintain the correct clearances to combustibles.

LA-38907

**COA #5760**

LA-39312

Certificate of Approval number, Fire Department - City of New York.

**NOTICE/AVISO/AVIS**

For trained personnel only: The installation manual and the wiring diagram for this appliance can be found inside the oven attached to the opposite side of this panel.

Solo para personal capacitado: El manual de instalación y el diagrama de cableado de este equipo se pueden encontrar dentro del horno, en el lado opuesto de este panel.

Personnel formé seulement : Le manuel d'installation et le schéma de câblage de cet appareil se trouvent à l'intérieur du four attachés de l'autre côté de ce panneau.

LA-38941

**NOTICE**

For trained personnel only: The installation manual and the wiring diagram for this appliance can be found inside the oven attached to the opposite side of this panel.

**WARNING/ADVERTENCIA/AVERTISSEMENT**

**Electric Shock Hazard**  
To reduce the risk of electric shock, do not remove or open cover. No user-serviceable parts inside. Refer servicing to qualified personnel.  
Qualified personnel: Disconnect power before servicing.

**Peligro de descarga eléctrica**  
Para reducir el riesgo de descarga eléctrica, no retire ni abra la cubierta. No hay piezas en el interior a la que se les pueda realizar mantenimiento. Derive el mantenimiento a personal calificado.  
Personal calificado: Desconecte la energía antes de realizar mantenimiento.

**Danger de décharge électrique**  
Pour réduire le risque de décharge électrique, ne par ouvrir ni retirer le capot. Ne contient pas de pièces réparables par l'utilisateur. Confier les réparations à du personnel qualifié.  
Personnel qualifié : Sectionnez l'alimentation avant toute intervention.

LA-38950

**WARNING**

Electric shock hazard

To reduce the risk of electric shock, do not remove or open cover. No user-serviceable parts inside. Refer servicing to qualified personnel.

Qualified personnel: Disconnect power before servicing.



Use \_\_\_\_\_ AWG for supply connections.  
Use only copper wires suitable for temperatures  $\geq 90^{\circ}\text{C}$ .  
Do not connect to a circuit operating at more than 150 VAC to ground.  
For use on individual branch circuits only.

Use AWG \_\_\_\_\_ para las conexiones de suministro.  
Use solo cables de cobre aptos para temperaturas mayores que  $90^{\circ}\text{C}$ .  
No conecte a un circuito que funcione a más de 150 V CA a tierra.  
Para su uso en circuitos derivados individuales solamente.

Utiliser du calibre \_\_\_\_\_ AWG pour les raccordements électriques.  
Utiliser exclusivement des conducteurs en cuivre qui conviennent à des températures  $\geq 90^{\circ}\text{C}$ .  
Ne pas raccorder à un circuit fonctionnant sous plus de 150 VCA par rapport à la terre.  
Utiliser exclusivement sur des circuits de dérivation propres.

**AWG**  
**90°C**

LA-38852

**Note:** This label is only used on UL-certified appliances that have 120V to ground wiring.

Use \_\_\_\_\_ AWG for supply connections.

Use only copper wires suitable for temperature less than or equal to  $90^{\circ}\text{C}$ .

Do not connect to a circuit operating at more than 150 VAC to ground.

For use on individual branch circuits only.

**NOTICE:** In order to be able to service this appliance, it must be installed with the casters supplied, a connector complying with ANSI Z21.69 — CSA 6.16 and a quick-disconnect device complying with ANSI Z21.41 — CSA 6.9. It must also be installed with the restraining means to guard against transmission of strain to the connector as specified in the appliance manufacturer's instructions.

**AVIS:** Pouvoir être entretenu, cet appareil doit être équipé des roulettes fournies, d'un connecteur conforme à la norme ANSI Z21.69 • CSA 6.16 et d'un connecteur à branchement rapide conforme à la norme ANSI Z21.41 • CSA 6.9. Il doit aussi comporter un dispositif empêchant que la traction soit transmise au connecteur, comme il est spécifié dans les instructions du fabricant.

**AUFSTELLUNG:** Gasanschluß und Inbetriebnahme dürfen nur durch autorisiertes Fachpersonal entsprechend der gültigen örtlichen Sicherheitsbestimmungen durchgeführt werden. Gasbetriebene Geräte dürfen nur dann beweglich aufgestellt, angeschlossen und in Betrieb genommen werden, wenn der Gasanschluß mit einer flexiblen Schlauchverbindung mit Schnellverschluß hergestellt wird und das Gerät mittels einer Vorrichtung (z.B. mit der Wand verankerte Kette) gegen unbeabsichtigtes Verschieben gesichert ist. Für die bewegliche Aufstellung sind ausschließlich die mitgelieferten Räder an den Geräten zu montieren.

**AVISO:** Para poder mantener esta aplicación, debe ser instalado con los ruedas provistos, con un conector homologado según el estándar ANSI Z21.69 o CSA 6.16 y con un dispositivo de desconexión rápida que cumpla con el estándar ANSI Z21.41 o CSA 6.9. También deberá instalarse un sistema de sujeción para evitar tensiones en el conector, procediendo según se indica en las instrucciones del fabricante del equipo.

注意——为了方便检修设备，必须安装设备自带的脚轮装置、一个符合ANSI Z21.69-6.16标准的连接器和一个符合ANSI Z21.41-6.9标准的快速断开装置。设备制造商说明书中明确规定，安装该脚轮时，必须采取防护措施，以避免移动设备时的拉力损坏脚轮。

LA-25784

**NOTICE:** Use only factory-supplied casters when needed. When this appliance includes casters, the following must also be installed:

- a connector complying with ANSI Z21.69 / CSA 6.16;
- a quick-disconnect device complying with ANSI Z21.41 / CSA 6.9;
- a restraining device to guard against transmission of strain to the connector as specified in the manual.

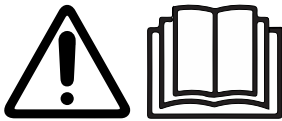

Consult instructions for operation and use.

USA	This appliance shall be installed in conformity with the local regulations and used only in well ventilated locations. Consult the instruction manual before installing this appliance.
DE: China	该仪器必须按照有关规定进行安装，并放置在通风的地方。安装使用该仪器前，请参考说明书。
DE: Germany	Das Gerät muss nach Lokalen Richtlinien installiert werden. Es kann nur in gut gelüfteten Bereichen verwendet werden. Siehe Gebrauchsanweisung vor dem Installieren des Gerätes.
DK: Denmark	Denne apparat skal installeres i overensstemmelse med de lokale vedtægter og må kun bruges på et sted med ordentlig ventilation. Læs instruktionerne inden du installerer dette apparat.
ES: Spain	Este equipo se debe instalar en conformidad con las normas locales y se debe usar sólo en lugares bien ventilado. Consulte las instrucciones antes de instalar este equipo.
FI: Finland	Tämä laite on asennettava paikallisia määräyksiä noudattaen, ja sitä saa käyttää ainoastaan tiloissa, joissa on hyvä ilmanvaihto. Tutustu käyttöoppaaseen ennen laitteen asentamista.
FR: France	Cet appareil doit être installé dans un espace bien aéré en conformité avec la réglementation en vigueur. Consultez le manuel d'instructions avant d'installer l'appareil.
GB: Britain	This appliance shall be installed in conformity with the local regulations and used only in well ventilated locations. Consult the instruction manual before installing this appliance.
GR: Greece	Η εγκατάσταση της συσκευής πρέπει να γίνει σε συμμόρφωση προς τους τοπικούς κανονισμούς και η χρήση της επιτρέπεται μόνο σε χώρους με καλό εξαερισμό. Προτού εγκαταστήσετε τη συσκευή, συμβουλευτείτε το εγχειρίδιο οδηγιών.
HU: Hungary	Ezt a készüléket a helyi szabványoknak megfelelően kell telepíteni, és csak jól szellőző helyeken szabad használni. A készülék telepítése előtt tanulmányozza át a használati útmutatót.
IT: Italy	Questo apparecchio deve essere installato in conformità della normativa locale e solo in aree ben ventilate. Prima di installare l'apparecchio, consultare il manuale delle istruzioni.
NL: Netherlands	Dit apparaat dient te worden geïnstalleerd conform de plaatselijke regelgeving en mag alleen gebruikt worden in goed geventileerde ruimten. Raadpleeg de handleiding voor u dit apparaat installeert.
PL: Poland	Urządzenie należy instalować zgodnie z lokalnymi przepisami i używać wyłącznie w pomieszczeniach z dobrą wentylacją. Przed zainstalowaniem urządzenia należy zapoznać się z instrukcją obsługi.
PT: Portugal	Este aparelho deverá ser instalado de acordo com os regulamentos locais e usado apenas em locais bem ventilados. Consulte o manual de instruções antes de instalar o aparelho.
RO: Romania	Acesta aparat va fi instalat în conformitate cu reglementările locale și va fi folosit doar în spații bine ventilate. Consultați manualul cu instrucțiuni înainte de instalarea aparatului.
RU: Russia	Этот прибор должен быть установлен в соответствии с местными нормативами и использоваться только в хорошо вентилируемом помещении. Прежде чем устанавливать этот прибор, изучите инструкцию по эксплуатации.
SE: Sweden	Denna produkt ska installeras i enlighet med lokala föreskrifter och enbart användas i väl ventilerade utrymmen. Läs bruksanvisningen innan produkten installeras.
SI: Slovenia	Napravo je treba namestiti skladno z lokalnimi predpisi in v gorajljati le v dobro prezračenih prostorih. Pred namestitvijo glejte navodila za uporabo.
TR: Turkey	Bu ekipmanın kurulumu yerel düzenlemelere uygun olarak yapılmalı ve ekipman iyi havalandırılmış ortamlarda kullanılmalıdır. Ekipmanın kurulumuna başlamadan önce kullanım kılavuzunu inceleyin.

	NATURAL	Cat	Gas Type
☑	DK/EE/PT/GR/HU/IS/IT/NO	I2H3B/P	2H-G20-20mba r
	RO/SE/SK/CY/PL/TR	I2H3B/P	2H-G20-20mba r
	ES/FR/GB/IE/PT/US/CZ	I2H3P	2H-G20-20mba r
	AT/CH	I2H3B/P	2H-G20-20mba r
	BE	I2E03B/P	2H-G20-20mba r
	DE	I2ELL3B/P	2E-G20-20mba r
	PROPANE	Cat	Gas Type
☑	DK/EE/PT/GR/HU/IS/IT/NO	I2H3B/P	3B/P-G30/G31-30mba r
	RO/SE/SK/CY/PL/TR	I2H3B/P	3B/P-G30/G31-30mba r
	ES/FR/GB/IE/PT/US/CZ	I2H3P	3P-G31-30mba r
	AT/CH	I2H3B/P	3B/P-G30/G31-50mba r
	BE	I2E03B/P	1P-G31-30mba r
	DE	I2ELL3B/P	3B/P-G30/G31-50mba r
	NL	I2L3B/P	3B/P-G30/G31-30mba r
☑	NL	I2L3B/P	2i-G25-25mba r
☑	AUS/NZ		NGN 1.0kPa
☑	AUS/NZ		1PG-X Propane 2.75 kPa
☑	Japan		Natural Gas 1.2k kPa
☑	Japan		LPG - Propane 2.8 kPa

LA-36742

This appliance shall be installed in conformity with the local regulations and used only in well ventilated locations. Consult the instruction manual before installing this appliance.

UNIT READY FOR NATURAL GAS  
 该设备可以使用天然气  
 LA-23732

Unit ready for natural gas.

UNIT READY FOR PROPANE GAS  
 设备可使用液化石油气

LA-23733

Unit ready for propane gas.

This page is intentionally left blank.

# How to Turn On and Turn Off the Oven

## Before you begin

- The oven must be connected to electric power.
- Make sure the gas supply is connected.
- Make sure the water supply is connected.

## Turning on the oven

To turn on the oven, do the following.

Step	Action
1.	<b>Touch</b> the ON/OFF button ①.

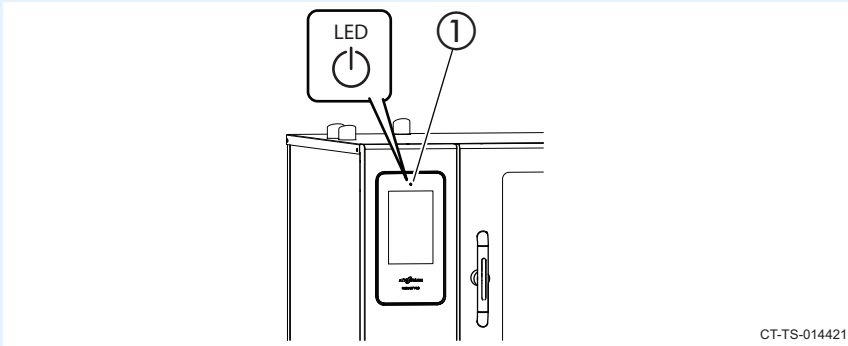

CT-TS-014421

The oven is now on.

## Turning off the oven

To turn off the oven, do the following.

2. **Touch** and hold the ON/OFF button ① until the "Shut Down Options" screen displays. **Touch** "Shut down" ②.

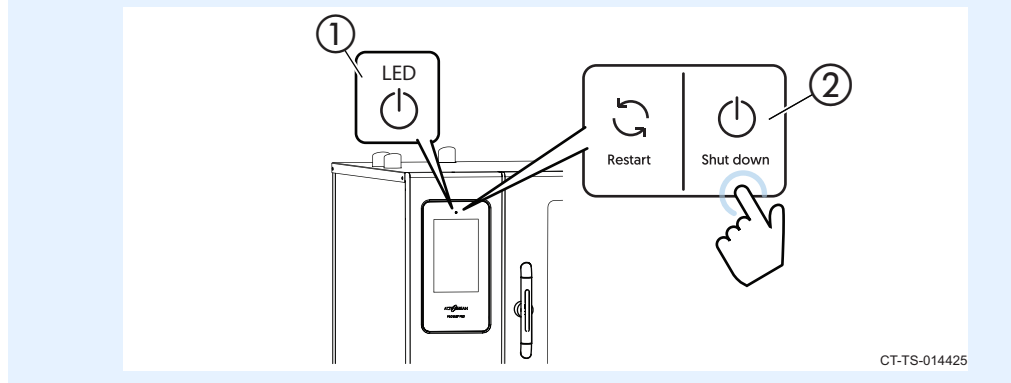

The oven is now off.

# How to Preheat the Oven

## Before you begin

### Make sure:

- The oven is turned on.
- The oven door is closed.

## Procedure

To preheat the oven, do the following.

Step	Action
1.	From the professional cook screen, <b>touch</b> the preheat icon ①. <b>Enter</b> the preheat temperature using the number pad. <b>Touch</b> the check mark.

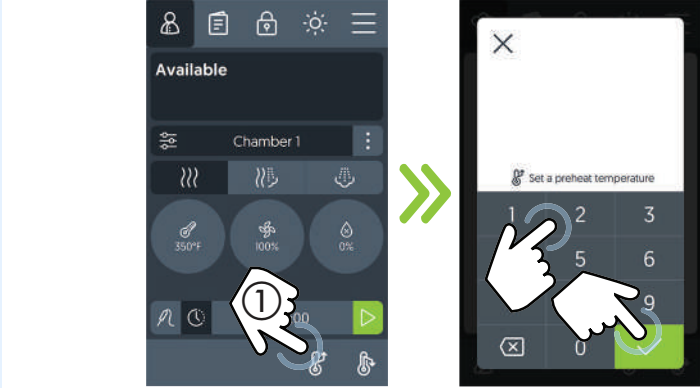

CT-TS-016250

## Screen loading bars

The loading bar indicates the progress towards reaching the set temperature. If necessary, touch the cancel icon ② to cancel the preheating process before the oven reaches its preheat temperature.

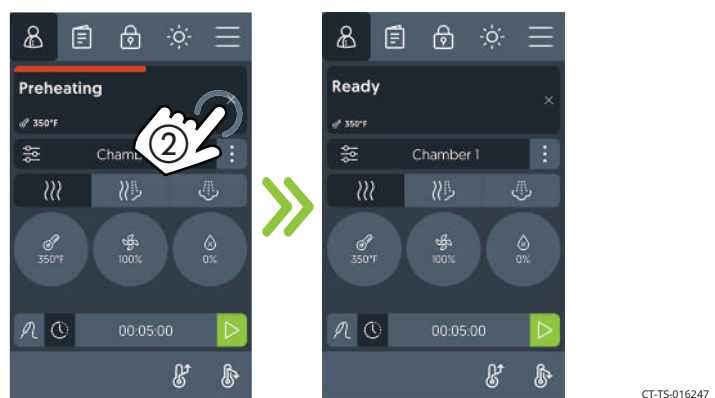

## Result

The oven is preheating. When the preheat process is complete, the screen displays Ready.

# How to Cook with Programmed Recipes

## Before you begin

### Make sure:

- The oven is preheated.
- Your food is prepared and ready to cook.

## Procedure

To cook using a programmed recipe, do the following.

Step	Action
------	--------

1. **Touch** the recipe book icon ①. The browse recipes screen displays.

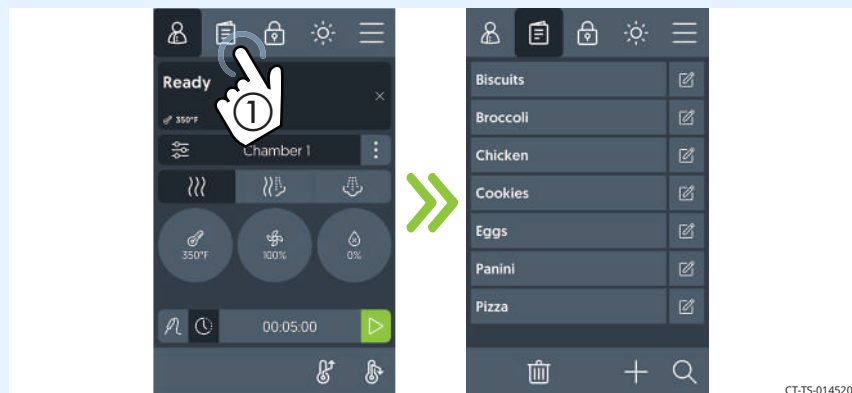

2. **Navigate** to the recipe.

**Open** the door and load the food into the cavity. **Close** the door.

**Touch** the recipe ②. The cooking process starts.

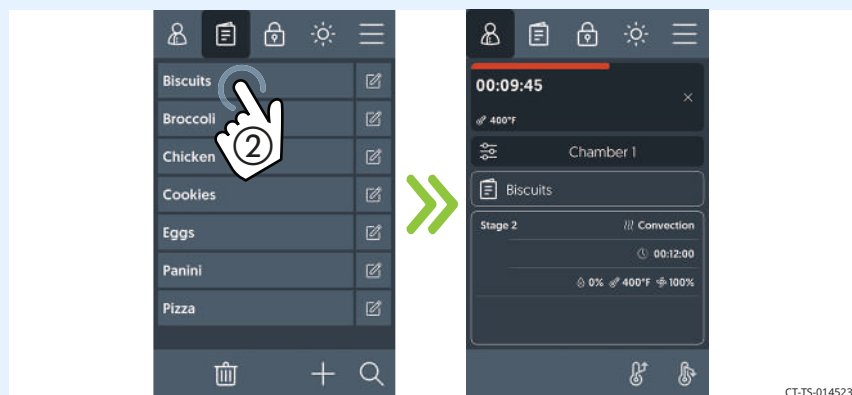

*Continued on next page*

*Continued from previous page*

**During the cooking process**

The cooking status screen displays the details on the current cook setting.  
 During the cooking process:

Action	Result
Touch the hand icon  when action is required...	to continue the cooking process.
Touch "X"...	to cancel the cooking process.

**Result**

At the end of the cooking process, the oven sounds an alert, and the cavity light flashes. Remove the cooked food.

# How to Cook in Professional Mode

## Before you begin

### Make sure:

- The oven is preheated.
- Your food is prepared and ready to cook.









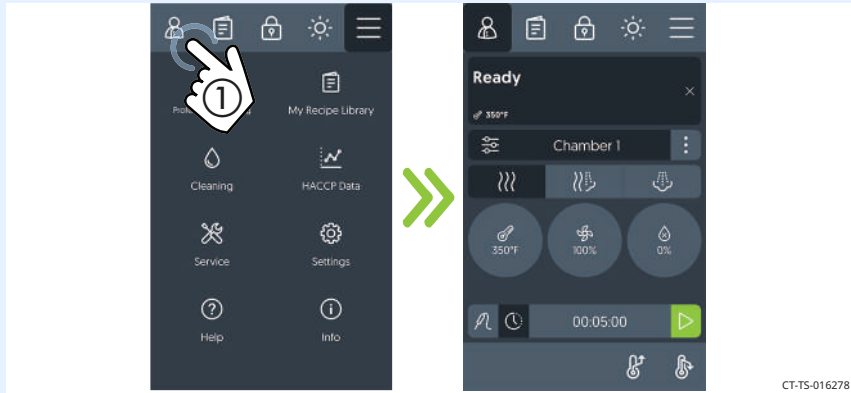
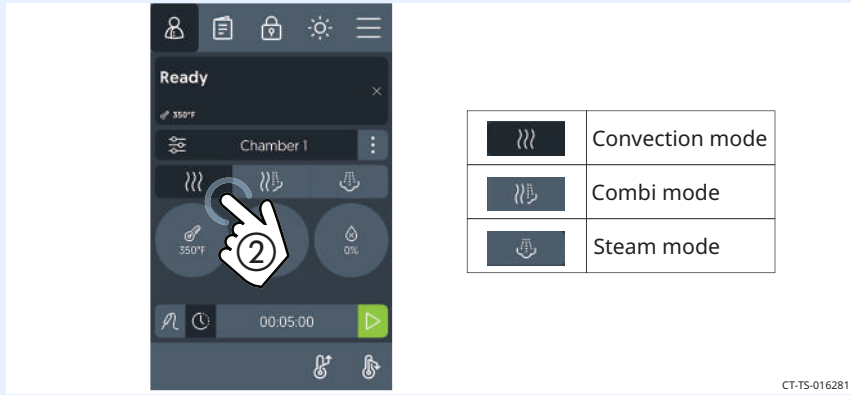

## Background

This procedure consists of:

- setting the food loading action;
- and setting the cooking stage parameters (temperature, time, humidity, and fan speed).

## Procedure

To cook in professional mode, do the following.

Step	Action						
1.	<p><b>Touch</b> the professional cook icon ①. The professional cook screen displays.</p>  <p>CT-TS-016278</p>						
2.	<p><b>Select</b> a cooking mode ②.</p>  <table border="1" data-bbox="1049 1444 1357 1608"> <tbody> <tr> <td></td> <td>Convection mode</td> </tr> <tr> <td></td> <td>Combi mode</td> </tr> <tr> <td></td> <td>Steam mode</td> </tr> </tbody> </table> <p>CT-TS-016281</p>		Convection mode		Combi mode		Steam mode
	Convection mode						
	Combi mode						
	Steam mode						

*Continued on next page*

Continued from previous page

3. **Touch** the cooking temperature icon ③. **Enter** the cooking temperature using the key pad.
- Touch** the fan speed icon ④. **Select** the fan speed.
- Touch** the humidity percentage icon ⑤. **Enter** the humidity percentage using the key pad.

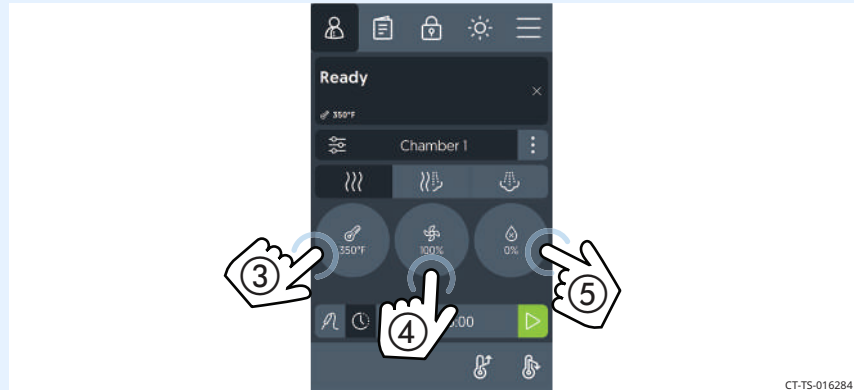

CT-TS-016284

4. If cooking by time, **touch** the cook by time icon ⑥. Then, **touch** the cooking time ⑦. **Enter** the cooking time using the key pad. **Touch** the check mark.

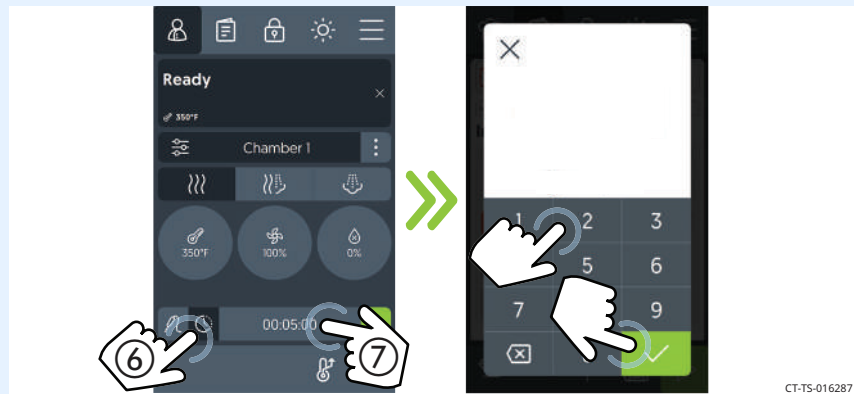

CT-TS-016287

Continued on next page

Continued from previous page

## Cooking by probe

5. If cooking by probe, **touch** the cook by probe icon (8). Then, **touch** the probe temperature (9). **Enter** the probe temperature set-point using the key pad. **Touch** the check mark.

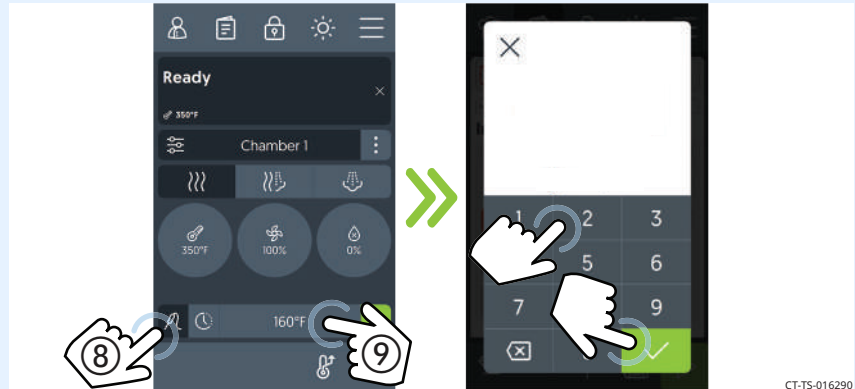

6. **Load** the food into the appropriate chamber.
7. **Touch** the start icon (10). The cooking process timer starts to count down.

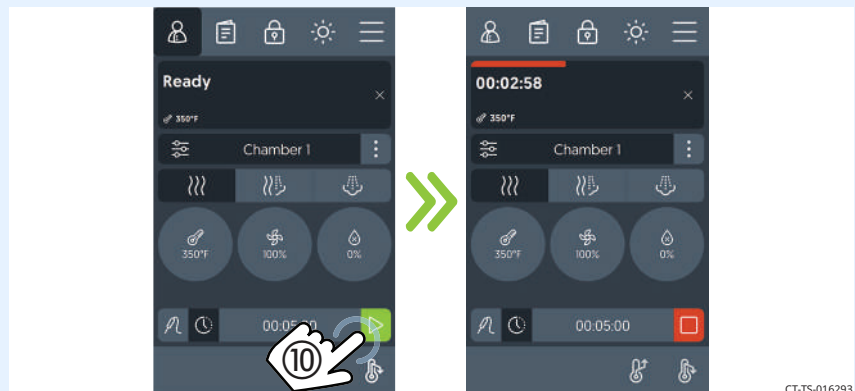

Continued on next page

Continued from previous page

**During the cooking process**

Action	Result
Touch the hand icon  when action is required...	to continue the cooking process.
Touch the chamber...	to show the recipe details.
Touch "X"...	to cancel the cooking process.

8. At the end of the cooking process, the oven sounds an alert, and the cavity light flashes.

9. **Open** the door and remove the hot food.



**NOTE:** Be sure to remove the cooked food after the cooking process is complete. If left inside the oven, the food will continue to cook.

**Result**

The food is now cooked.

# How to Use the Multiple Shelf Timers

## Before you begin

### Make sure:

- The oven is preheated.
- Your food is prepared and ready to cook.

## Background

There may be times when you will want to cook multiple pans of food at the same time, but at different intervals. The dual timer function allows you to do so.

## Procedure

To cook using multiple timers, do the following.

Step	Action
------	--------

1. **Touch** the professional cook icon ①. The professional cook screen displays.

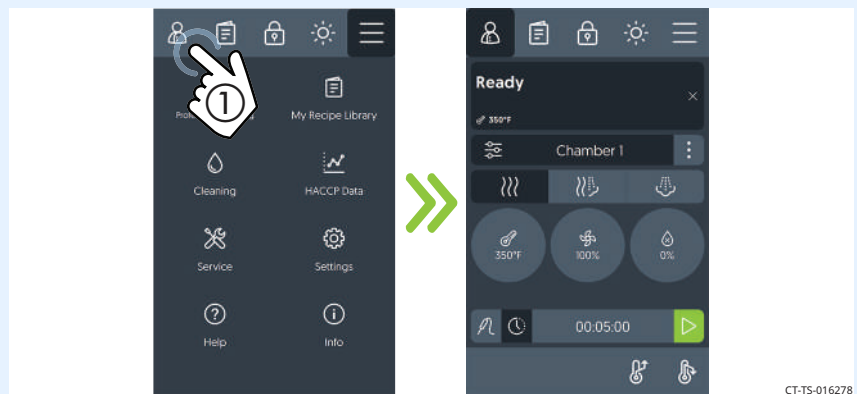

2. **Select** a cooking mode ②.

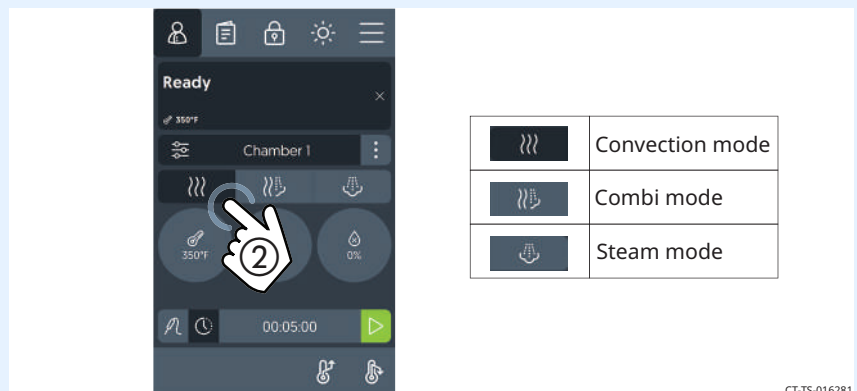

*Continued on next page*

Continued from previous page

3. **Touch** the cooking temperature icon ③. **Enter** the cooking temperature using the key pad.
- Touch** the fan speed icon ④. **Select** the fan speed.
- Touch** the humidity percentage icon ⑤. **Enter** the humidity percentage using the key pad.

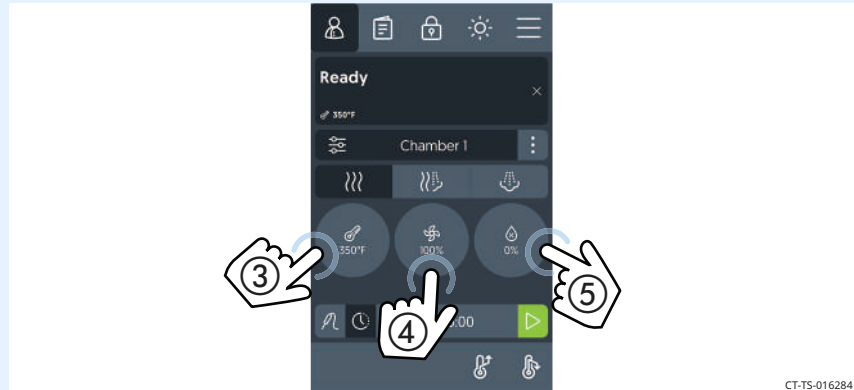

CT-TS-016284

4. **Touch** the chamber options icon ⑥. Then, **touch** the multiple shelf icon ⑦.

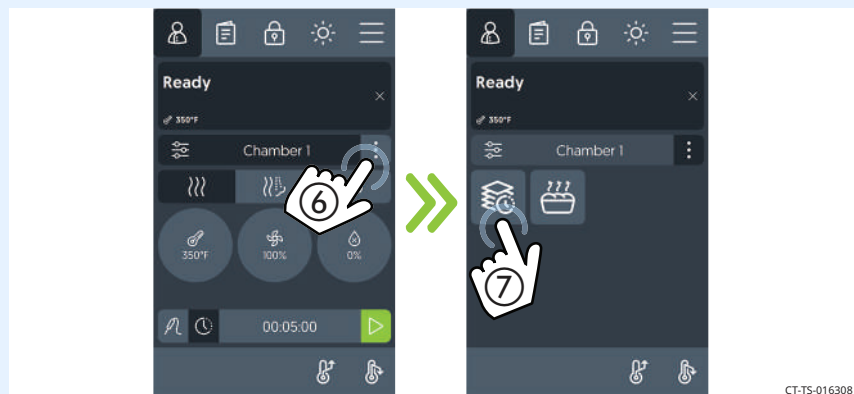

CT-TS-016308

Continued on next page

Continued from previous page

5. **Touch** the cooking time ⑧. **Enter** the cooking time using the key pad. **Touch** the check mark.

**NOTE:** To cook by probe for shelf one, touch the cook by time icon. This sets the first shelf to probe cooking. Note that probe cooking is only available for shelf one.

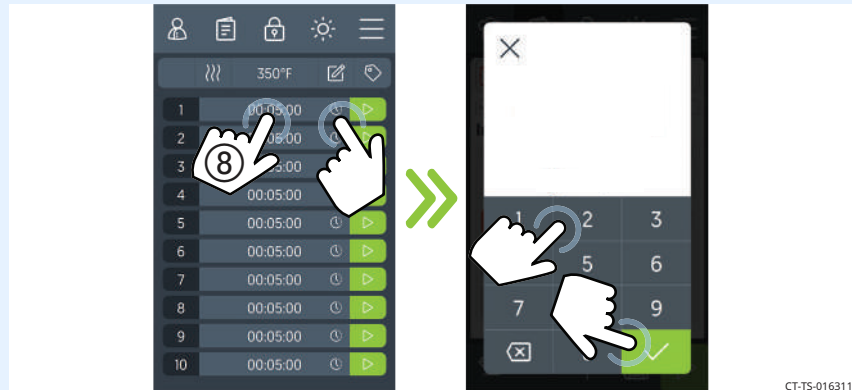

6. **Enter** the cooking time ⑨ for the second pan of food.

**NOTE:** To change the number of shelves, touch the edit icon. Then touch the plus or minus icons to increase or decrease the number of shelves.

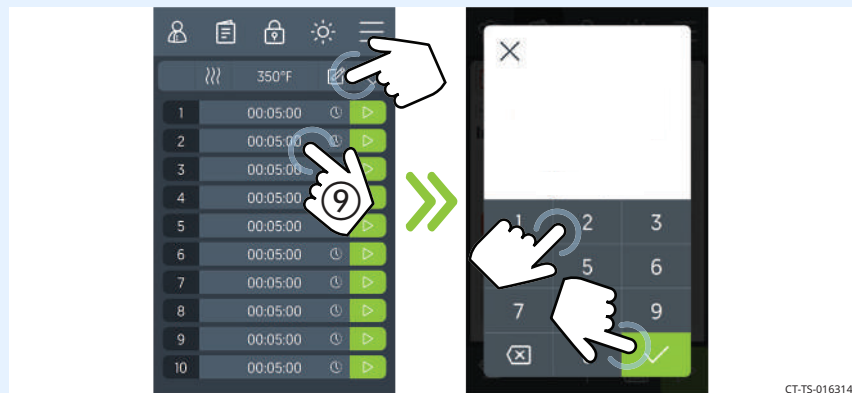

Continued on next page

Continued from previous page

7. **Load** pan 1 into the oven.

**Touch** the start icon ⑩.

The cooking stage timer starts to count down for pan 1.

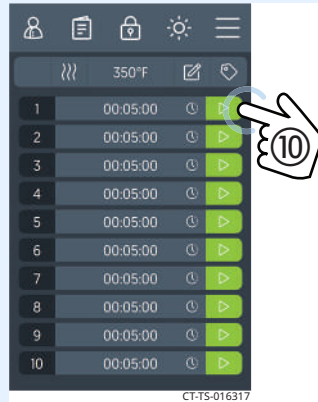

8. **Load** pan 2 into the oven.

**Touch** the start icon ⑪.

The cooking stage timer starts to count down for pan 2.

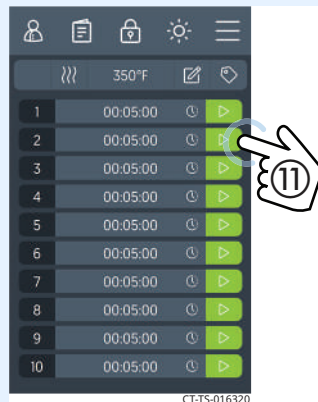

At the end of the cooking process, the oven sounds an alert, and the cavity light flashes.

9. **Open** the door and remove the hot food.



**NOTE:** Be sure to remove the cooked food after the cooking process is complete. If left inside the oven, the food will continue to cook.

**Result**

The food is now cooked.

# How to Lock and Unlock the Screen

## Before you begin

The oven is turned on.

## Background

The screen can be locked to prevent changes being made during the cooking process.

## Procedure

To lock and unlock the screen, do the following.

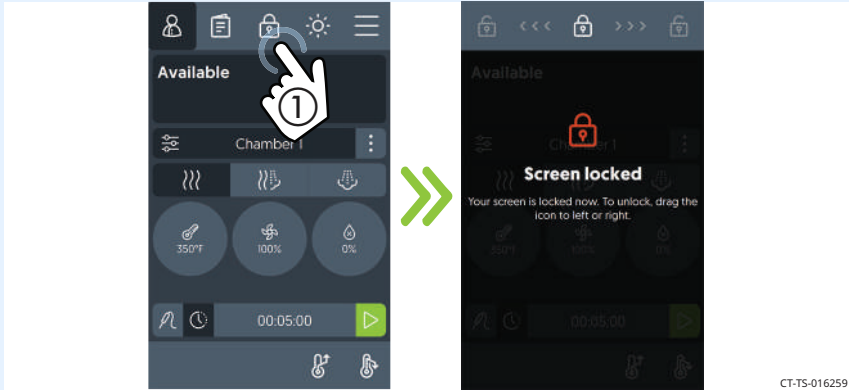
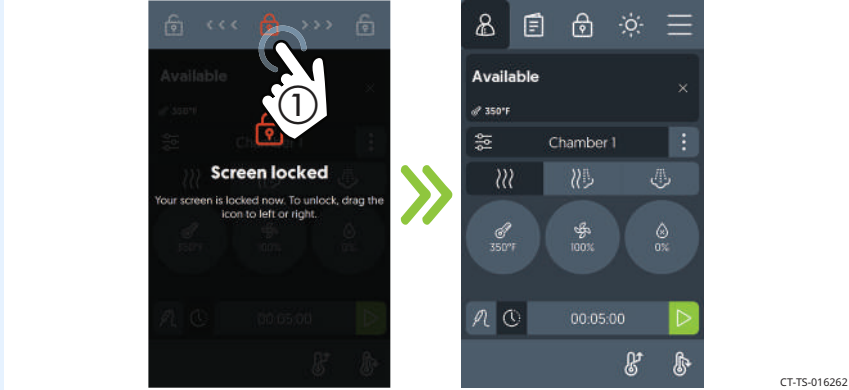
Step	Action
1.	<p><b>Touch</b> the lock icon ①. The screen is now locked.</p>  <p>CT-TS-016259</p>
2.	<p>To unlock the screen, <b>touch and hold</b> the lock icon ① and drag it to the right or left of the screen.</p>  <p>CT-TS-016262</p>

## Result

The screen is now locked or unlocked.

# How to Cool Down the Oven

## Background

There are two methods to cool down the oven. The regular cool down uses the convection fan and requires the door to be open. The rapid cool down uses water and requires the door to be closed.



**WARNING:** Burn hazard.

Open the door carefully. Escaping hot vapors or steam can cause injury.

## Procedure

To cool down the oven, do the following.

Step	Action
------	--------

1. From the manual cooking screen, **touch** the cool down icon ①. The select cool down screen displays.

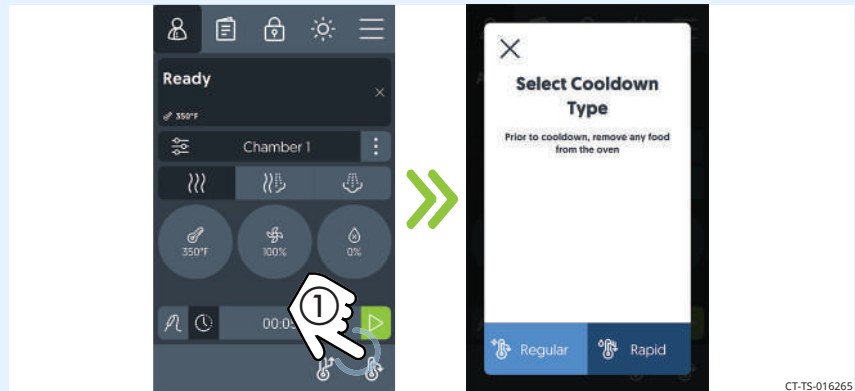

*Continued on next page*

Continued from previous page

## Regular cool down

2. For a regular cool down, **touch** the “Regular” ② cool down icon.

**Enter** the cool down temperature using the number pad. **Touch** the check mark. **Open** the door slowly to vent any steam for 3–5 seconds. Then, leave the door open 4 to 6 inches (10 to 15 cm).

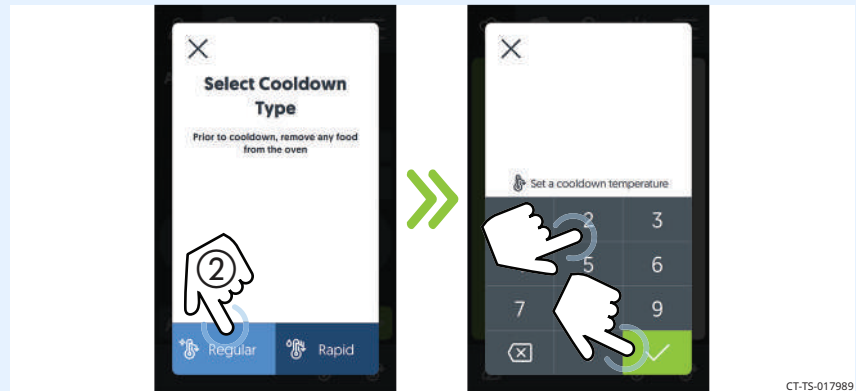

**NOTE:** The oven activates the convection fan for the cool down process. The oven deactivates the convection fan when the cool down process is complete.

## Rapid cool down

3. For a rapid cool down, **touch** the “Rapid” ③ cool down icon.

**Make sure** the door is closed. **Enter** the cool down temperature using the number pad. **Touch** the check mark.

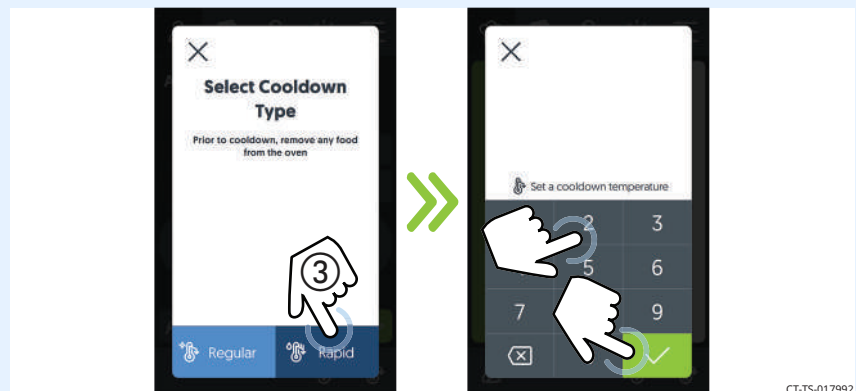

**NOTE:** The rapid cool down system sprays water into the oven cavity when the temperature is 500°F (260°C) or lower.

Continued on next page

Continued from previous page

### Cooling down progress bars

The progress bar indicates the oven's progress towards reaching its cool down temperature.

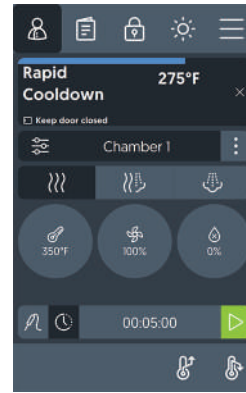
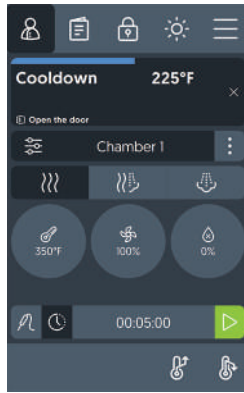

CT-TS-016268

### Result

The oven is now cooled down.

# How to Create a Recipe

## Background

Creating a recipe consists of:

- Setting the cooking stage(s) parameters (temperature, time, humidity percentage, and fan speed);
- setting an action step if desired such as adding an ingredient;
- naming the recipe;
- adding a description to the recipe;
- adding a photo to the recipe;
- and adding the recipe to a category.

## Procedure

To create a recipe, do the following.

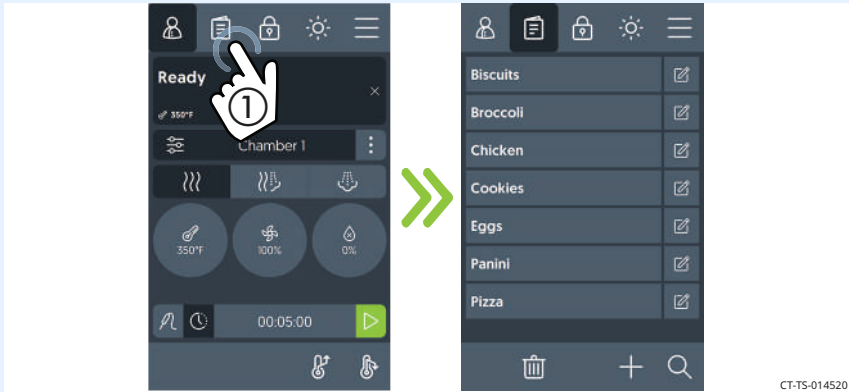
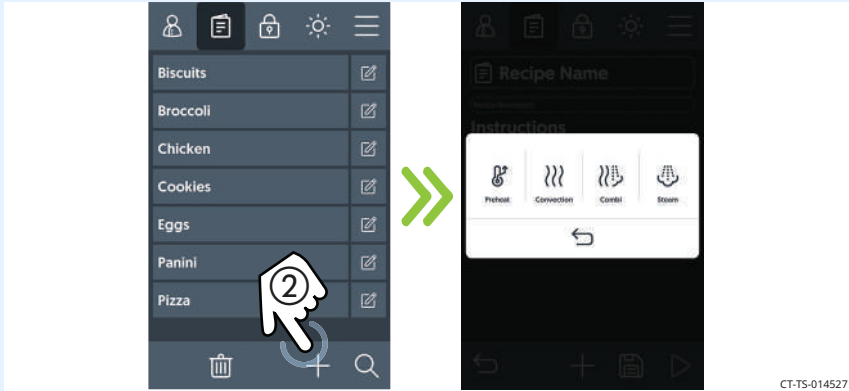
Step	Action
1.	<p><b>Touch</b> the recipe book icon ①. The browse recipes screen displays.</p>  <p>CT-TS-014520</p>
2.	<p><b>Touch</b> the plus icon ②. The step type screen displays.</p>  <p>CT-TS-014527</p>

*Continued on next page*

Continued from previous page

3. **Touch** the step type icon ③ to choose the step type.

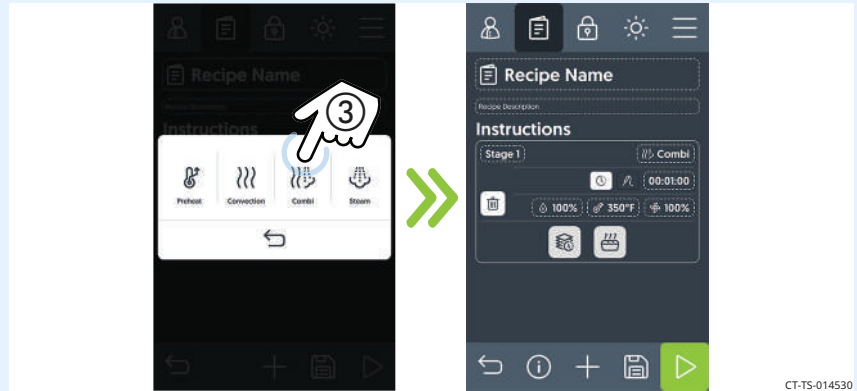

4. **Touch** "Recipe Name" ④. The recipe name screen displays.

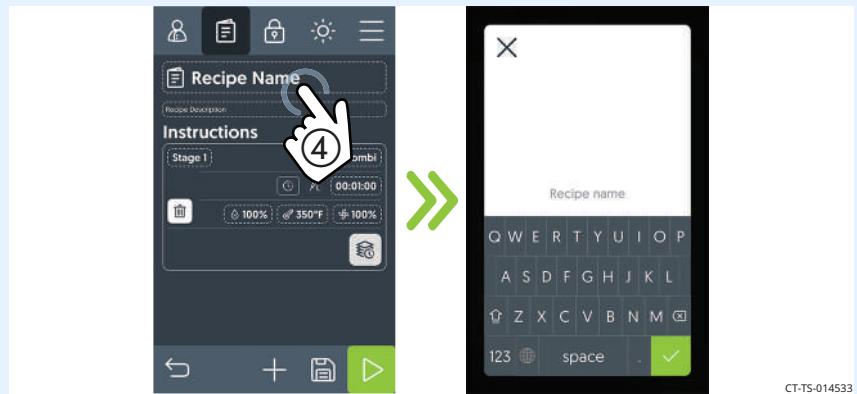

5. **Enter** the recipe name. **Touch** the check mark icon ⑤ to return to the create recipe screen.

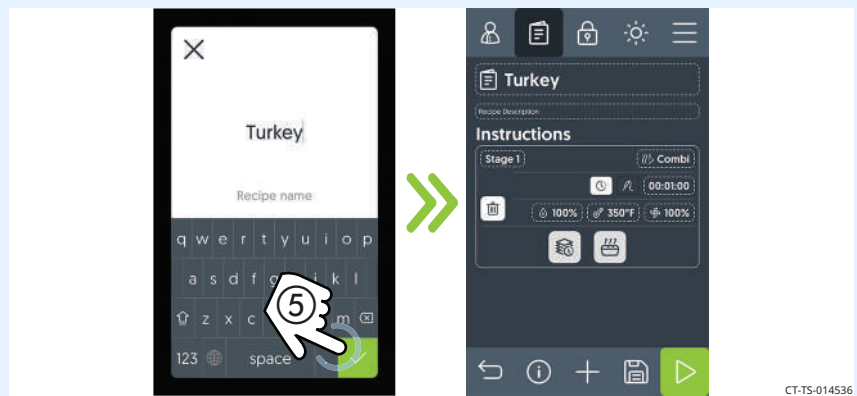

Continued on next page

Continued from previous page

6. **Touch** "Recipe Description" ⑥. The recipe description screen displays. **Enter** the recipe description. **Touch** the check mark icon to return to the create recipe screen.



7. **Touch** the cook by time icon or cook by probe icon ⑦. **Touch** the cooking time or probe set-point temperature ⑧. **Enter** the cooking time or probe temperature using the key pad. **Touch** the check mark.



Continued on next page

Continued from previous page

8. **Touch** the humidity icon ⑨. **Enter** the humidity percentage using the key pad. **Touch** the check mark.

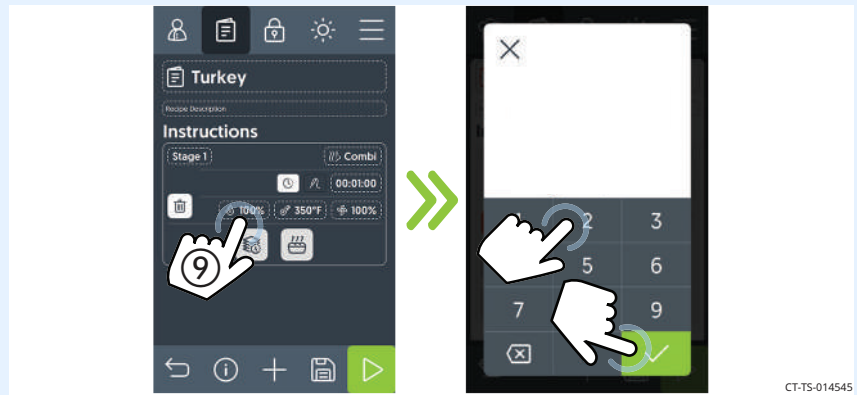

9. **Touch** the chamber temperature set-point icon ⑩. **Enter** the chamber temperature set-point using the key pad. **Touch** the check mark.



10. **Touch** the fan speed icon ⑪ to set the fan speed. **Touch** the check mark.

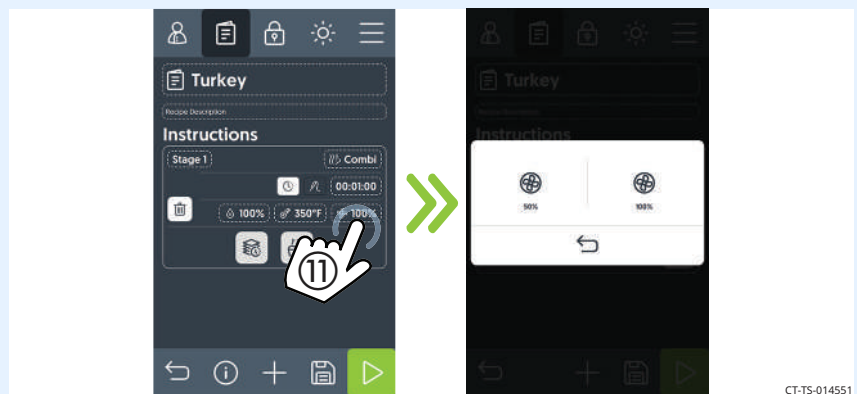

Continued on next page

Continued from previous page

11. **Touch** the plus icon (12) to add an additional stage or action.  
**Touch** the delete icon (13) to delete a stage or action.

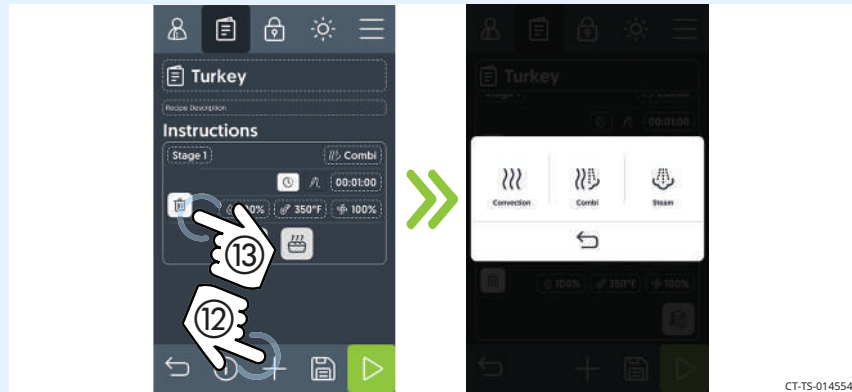

12. **Touch** the save icon (14) when finished to save the recipe.

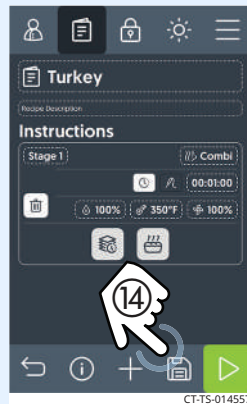

## Result

A new recipe has been created.

# How to Modify or Delete a Recipe

## Procedure

To modify, duplicate, or delete a recipe, do the following.

Step	Action
1.	<b>Touch</b> the recipes icon ①. The “Browse Recipes” screen displays.
	
2.	To modify a recipe, <b>touch</b> the recipe edit icon ② of the desired recipe.
	

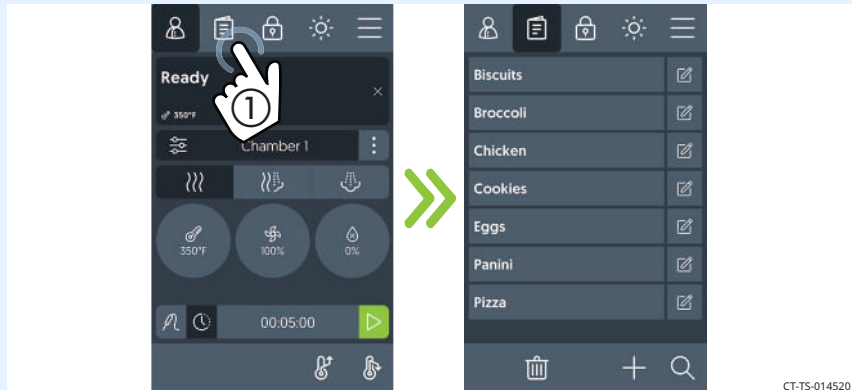

CT-TS-014520

## Modifying

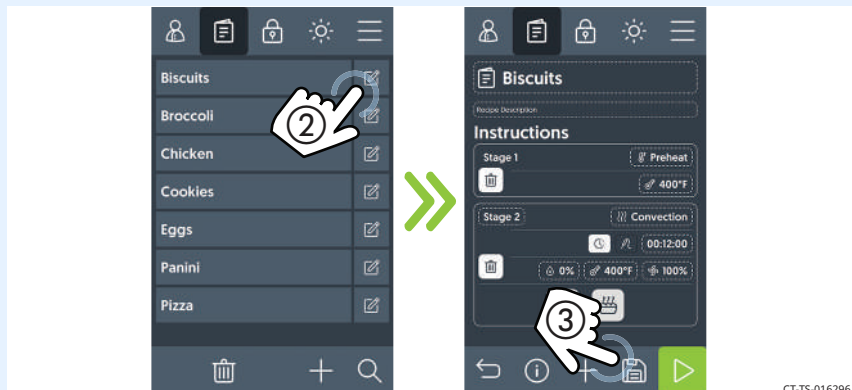

CT-TS-016296

The first stage of the recipe displays. There will be a screen for each stage. Scroll to the stage you want to modify.

- **Touch** the cook by time or cook by probe icon then modify the value using the key pad.
- **Touch** the humidity icon to modify the humidity percentage.
- **Touch** the chamber set-point icon to modify the chamber temperature.
- **Touch** the fan speed icon to modify the fan speed.

**Touch** the save icon ③ when finished.

**Touch** the trash icon to delete the stage, if desired.

*Continued on next page*

Continued from previous page

## Deleting

3. To delete a recipe, **touch** the delete icon ④.

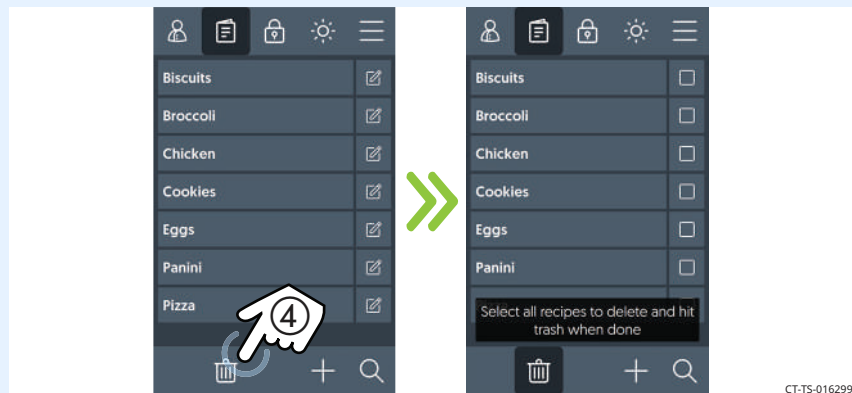

**Select** the recipe(s) that you want to delete. **Touch** the delete icon again. **Touch** "Continue" to confirm that you want to delete the recipe(s).

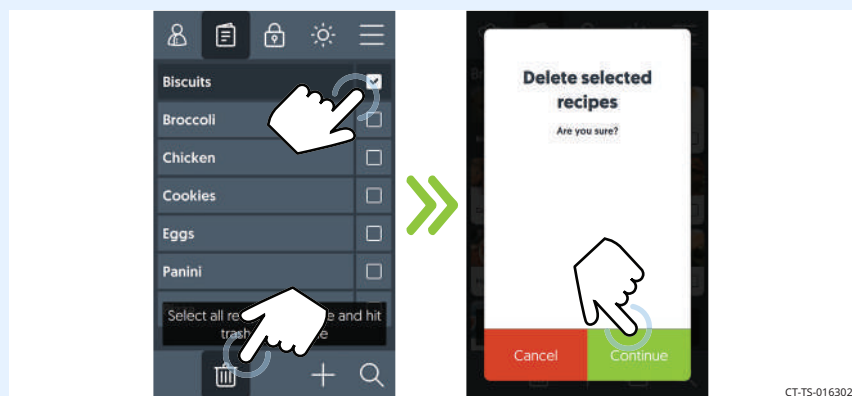

## Result

The procedure is now complete.

# How to Backup or Restore Settings with a USB Drive

## Before you begin

You will need a USB drive.

## Procedure

To backup or restore settings with a USB drive, do the following.

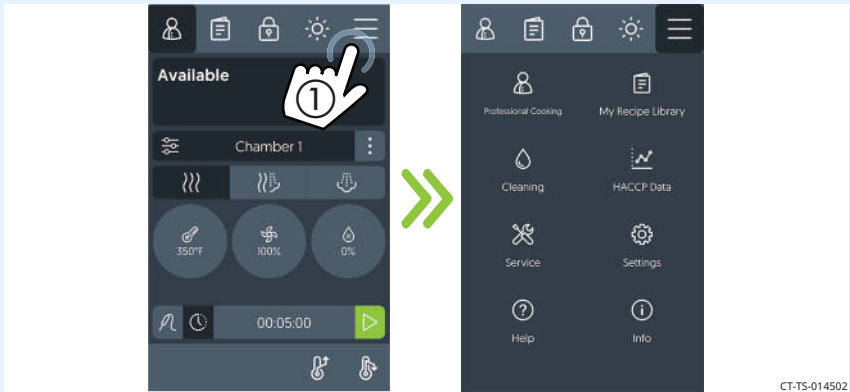
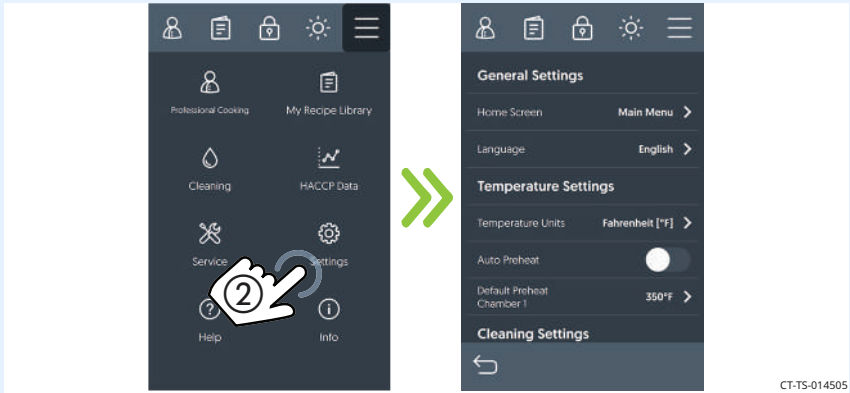
Step	Action
1.	<p><b>Touch</b> the menu icon ①. The menu screen displays.</p>  <p style="text-align: right;">CT-TS-014502</p>
2.	<p><b>Touch</b> the “Settings” icon ②. The “General Settings” screen displays.</p>  <p style="text-align: right;">CT-TS-014505</p>

*Continued on next page*

Continued from previous page

3. **Plug** the USB drive ③ into the port.

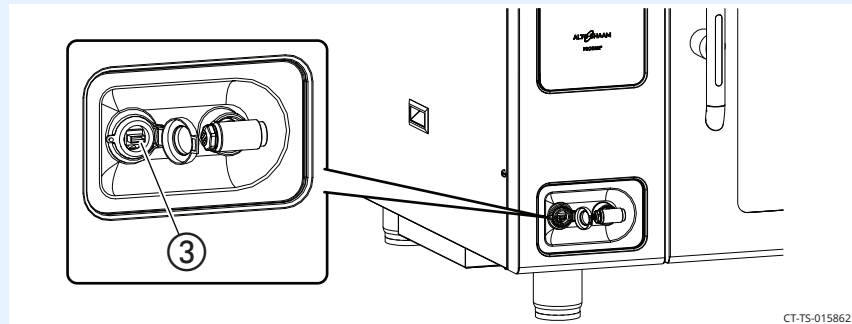

4. **Scroll** to "System Backup & Update."

**Touch** "Backup Settings to USB" or "Restore Settings from USB" ④. The USB screen displays.

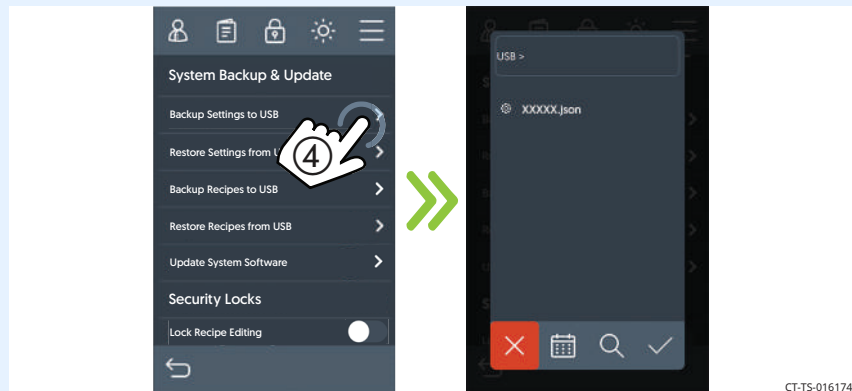

Continued on next page

Continued from previous page

5. **Select** the settings file ⑤.
- Touch** the check mark ⑥.

**NOTE:** Subfolders can be set up on the USB drive from your computer. To import settings from a subfolder, touch a subfolder, select the settings file, then touch the check mark.



CT-TS-017995

**Loading the recipes**

The oven downloads or restores the settings. When the process is complete, **touch** the check mark to return to the general settings screen. **Remove** the USB drive.

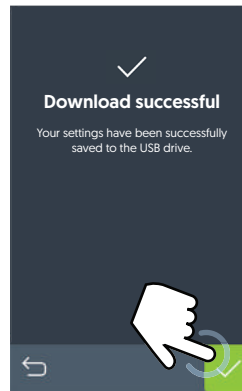

CT-TS-016183

**Result**

The settings have now been saved to the USB drive or restored from the USB drive.

# How to Backup Recipes to a USB Drive

## Before you begin

You will need a USB drive.

## Procedure

To backup recipes from the oven to a USB drive, do the following.

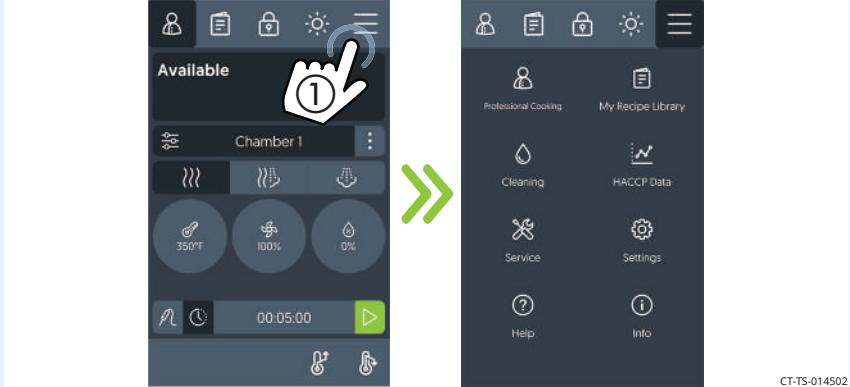
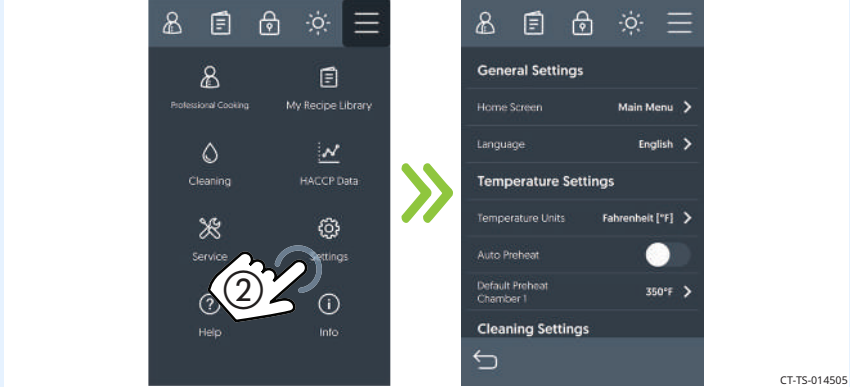
Step	Action
1.	<p><b>Touch</b> the menu icon ①. The menu screen displays.</p>  <p>CT-TS-014502</p>
2.	<p><b>Touch</b> the "Settings" icon ②. The "General Settings" screen displays.</p>  <p>CT-TS-014505</p>

*Continued on next page*

Continued from previous page

3. **Plug** the USB drive ③ into the port.

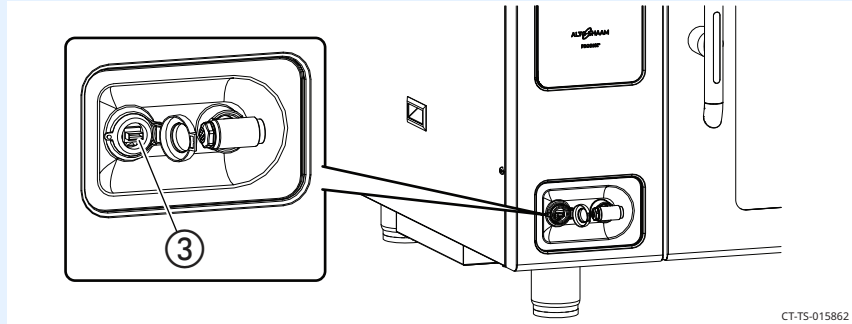

4. **Scroll** to “System Backup & Update.”  
**Touch** the “Backup Recipes to USB” ④ setting. The USB screen displays.

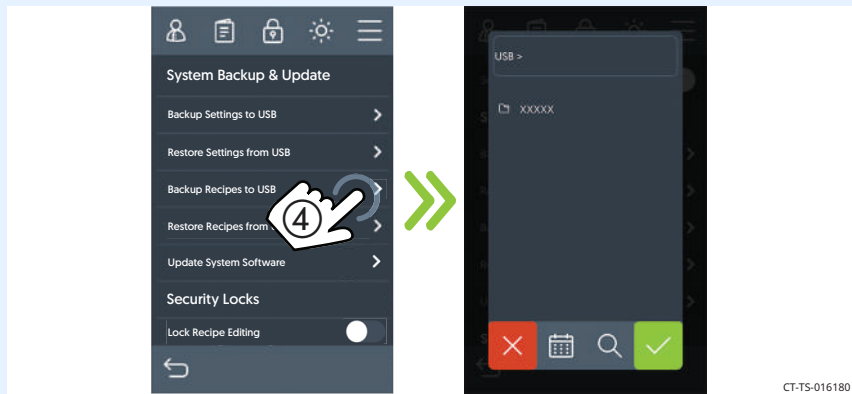

5. **Touch** the check mark ⑤ to save recipes to the top level of the USB drive.

**NOTE:** Subfolders can be set up on the USB drive from your computer. To save a file to a subfolder, touch a subfolder then touch the check mark.

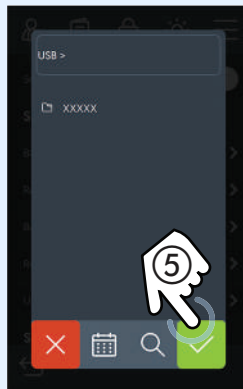

Continued on next page

*Continued from previous page*

## Loading the recipes

The oven downloads the recipes onto the USB drive. When the process is complete, the “Download successful” screen displays. **Touch** the check mark **⑥** to return to the general settings screen. **Remove** the USB drive.

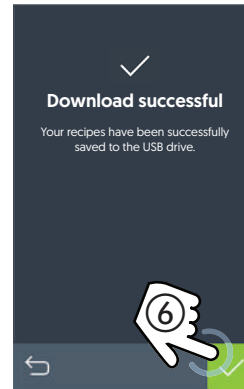

CT-TS-016189

## Result

The recipes are now saved to the USB drive.

# How to Restore Recipes from a USB Drive

## Before you begin

You will need a USB drive loaded with recipes.

## Procedure

To restore recipes from the USB drive to the oven, do the following.

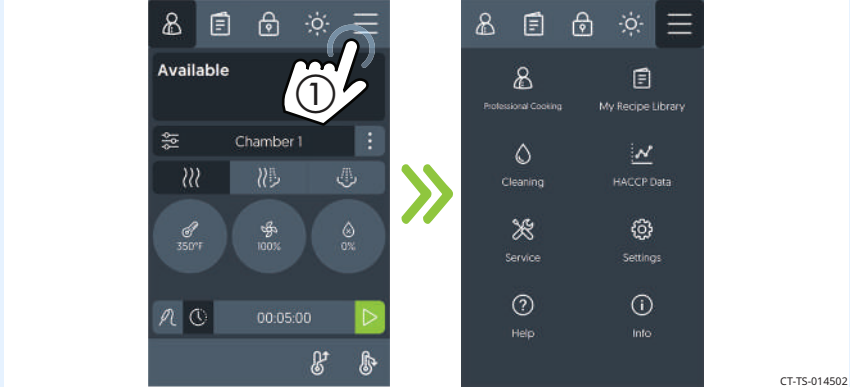
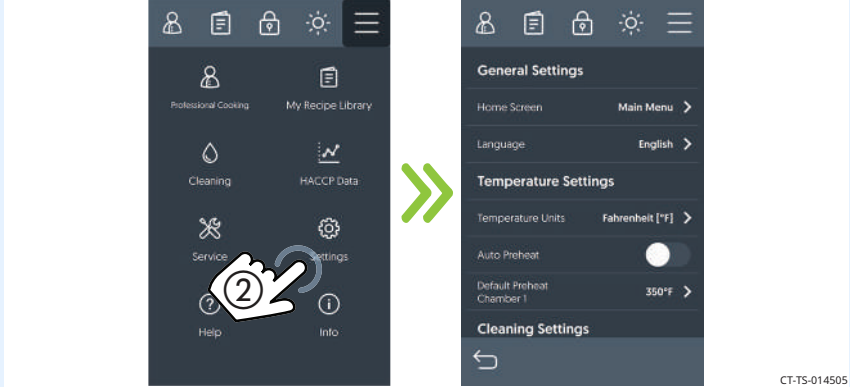
Step	Action
1.	<p><b>Touch</b> the menu icon ①. The menu screen displays.</p> 
2.	<p><b>Touch</b> the "Settings" icon ②. The "General Settings" screen displays.</p> 

*Continued on next page*

Continued from previous page

3. **Plug** the USB drive ③ into the port.

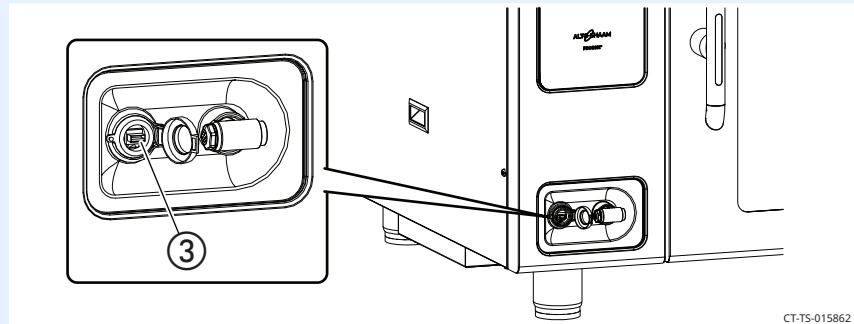

4. **Scroll** to “System Backup & Update.”  
**Touch** the “Restore Recipes from USB” ④ setting. The USB screen displays.

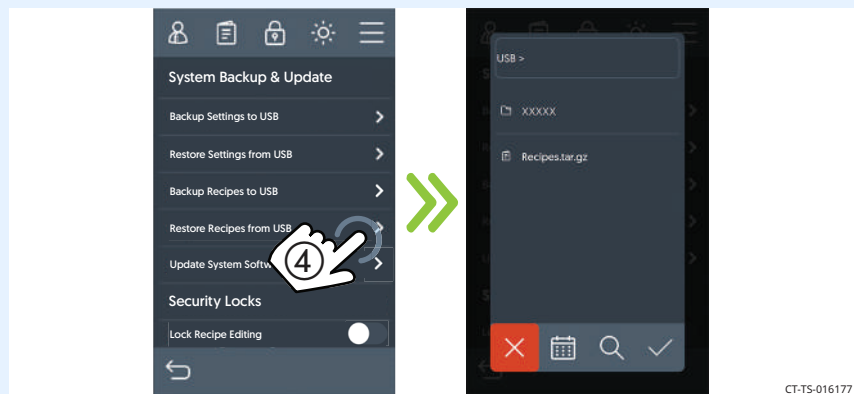

5. **Select** the recipe file ⑤.  
**Touch** the check mark ⑥ to load the recipes to the oven.

**NOTE:** Subfolders can be set up on the USB drive from your computer. To load a file from a subfolder, touch a subfolder then touch the check mark.

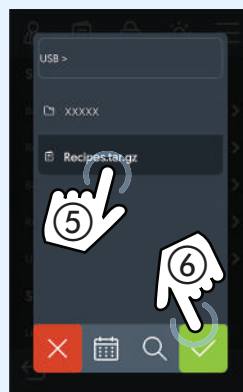

Continued on next page

*Continued from previous page*

## Loading the recipes

The oven loads the recipe file. When the process is complete, the “Recipes uploaded” screen displays. **Touch** the check mark ⑦ to return to the general settings screen. **Remove** the USB drive.

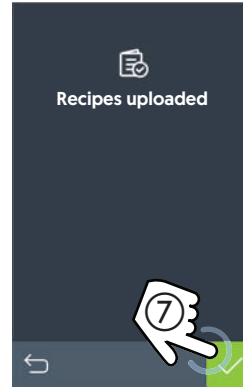

CT-TS-016186

---

## Result

The recipes are now loaded.

# How to Update Software with a USB Drive

## Before you begin

### Make sure:

- The oven is on and cool to the touch (room temperature).
- You will need a USB drive with the updated software. To download the most up to date oven software and register for email notifications when new software versions are released, please visit <https://www.alto-shaam.com/en/customer-support/software-downloads>.
- Do not remove the USB drive during the update process.

## Procedure

To update the software, do the following.

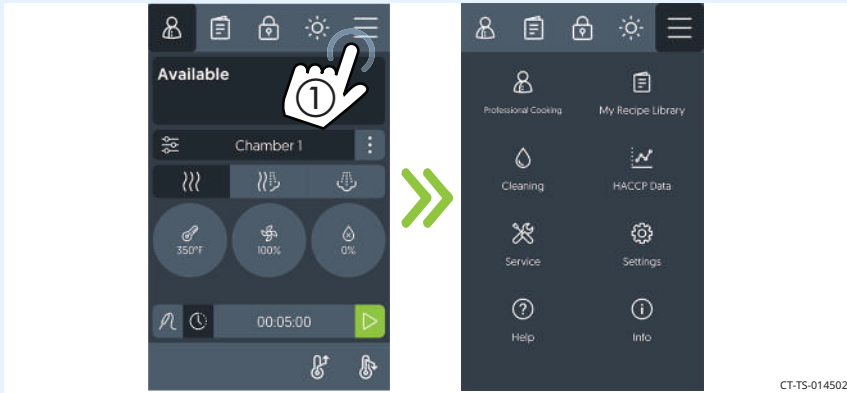
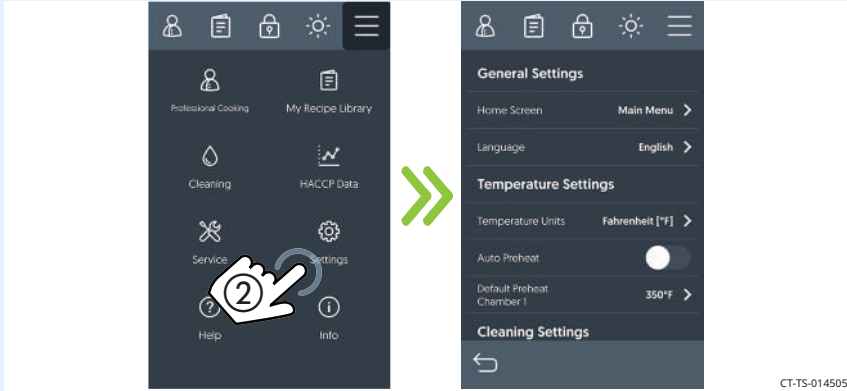
Step	Action
1.	<p><b>Touch</b> the menu icon ①. The menu screen displays.</p> 
2.	<p><b>Touch</b> the “Settings” icon ②. The “General Settings” screen displays.</p> 

*Continued on next page*

Continued from previous page

3. **Plug** the USB drive ③ into the port.

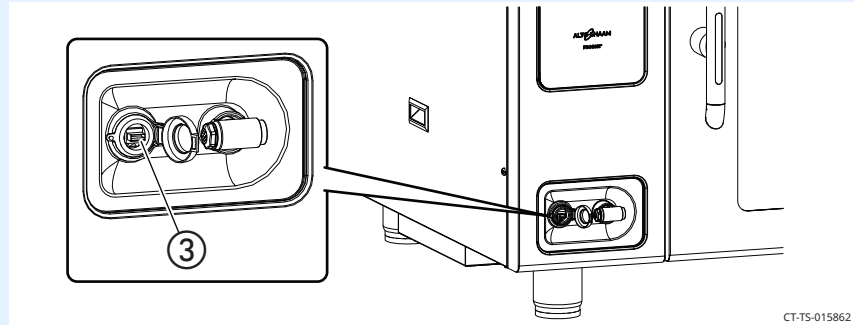

4. **Scroll** to “System Backup & Update.”  
**Touch** the “Update System Software” ④ setting.

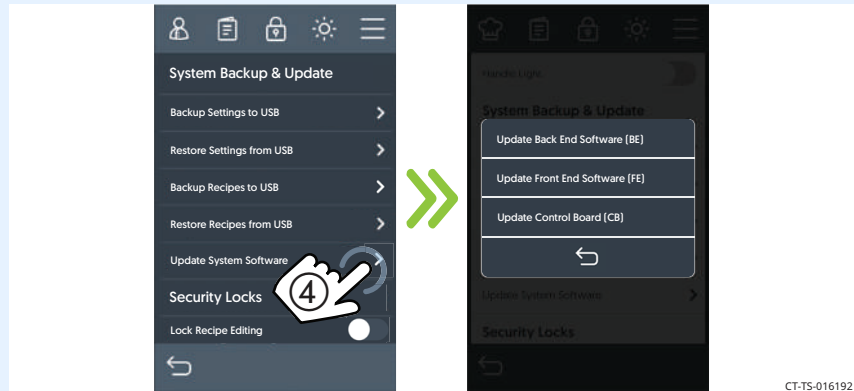

**NOTICE** Do not remove the USB drive during the update process.

5. **Touch** “Update Back End Software (BE)” to update the supporting software between the control board (CB) and interface board (IB). **Select** the ASBE.bin file ⑤. **Touch** the check mark ⑥. The oven loads the selected software. Touch the check mark ⑦ when the update is complete to restart the oven.

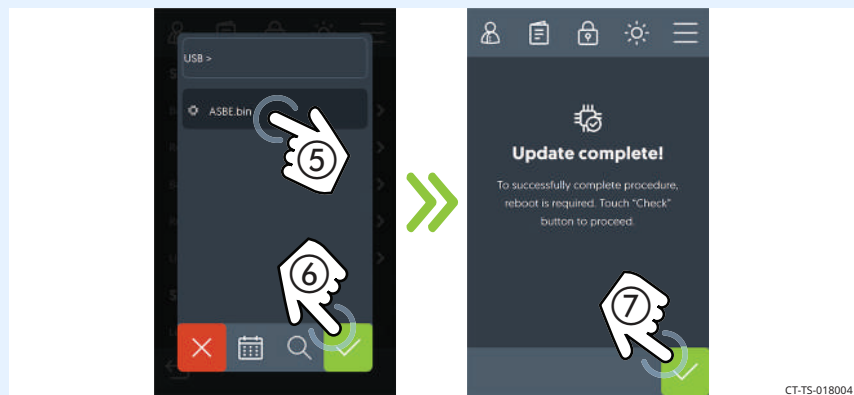

Continued on next page

Continued from previous page

6. **Repeat** steps 1 through 4.

**Touch** "Update Front End Software (FE)" to update the user interface software. Select the ASFE.bin file ⑧. Touch the check mark ⑨. The oven loads the selected software. Touch the check mark ⑩ when the update is complete to restart the oven.

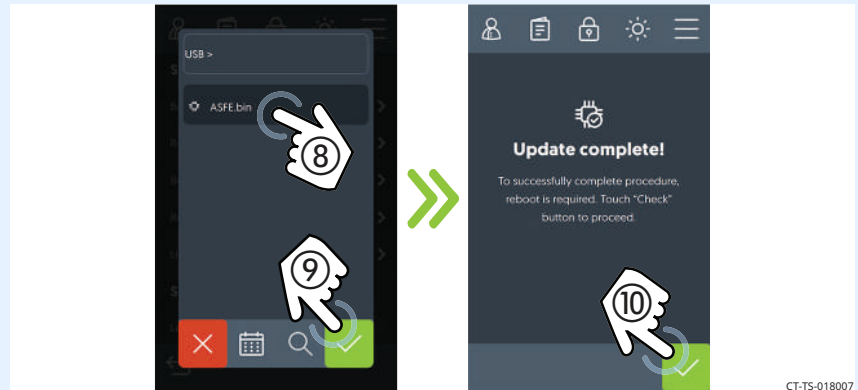

7. **Repeat** steps 1 through 4.

**Touch** "Update Control Board (CB)" to update the control board. Select the file ⑪. **Touch** the check mark ⑫. The oven loads the selected software. The oven verifies the file and then updates the CB. **Touch** the check mark ⑬ when the update is complete to restart the oven.

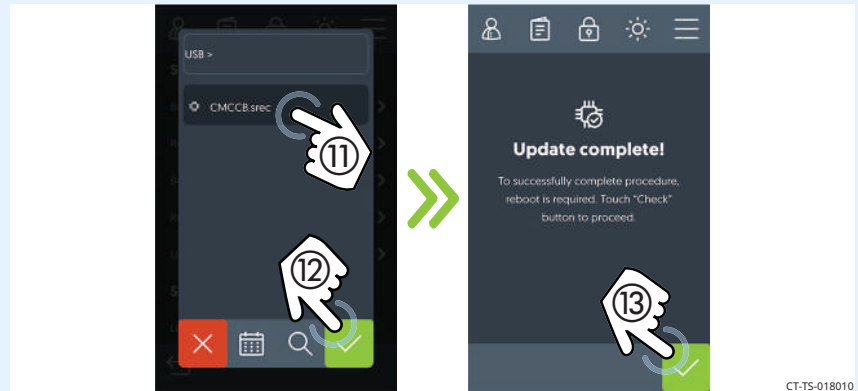

Continued on next page

Continued from previous page

8. **Remove** the USB drive.

9. **Touch** the "Info" icon (14) to validate the software versions.

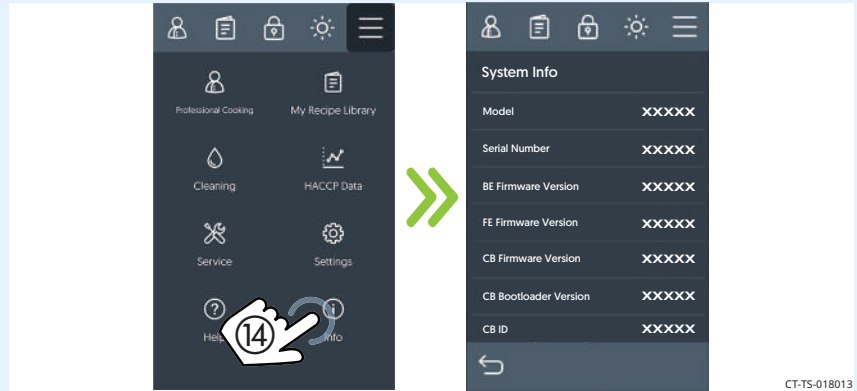

**Result**

The software has now been updated.

# How to Temporarily Change Languages

## Background

This procedure is to allow a quick change from one language to another on the oven display screen. The language will revert back to the original language when oven power is cycled.

## Procedure

To change language, do the following.

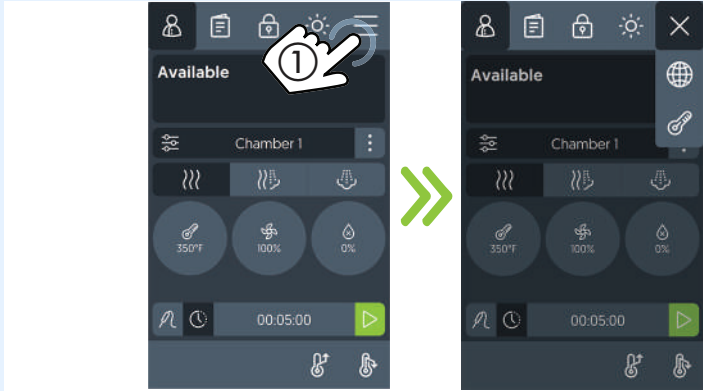
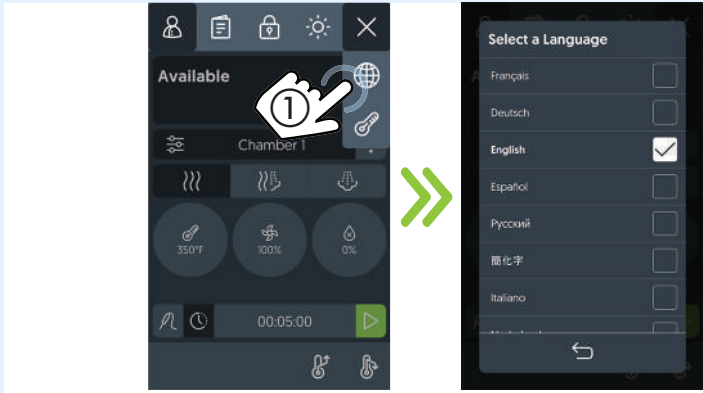
Step	Action
1.	<p><b>Touch and hold</b> the menu icon ①. The language select icon displays.</p>  <p style="text-align: right;">CT-TS-018434</p>
2.	<p><b>Touch</b> the language select icon ②. The “Select a Language” screen displays.</p> <p><b>Touch</b> the language you wish to use. It will translate the oven operating functions into that language. Recipes language will not change.</p>  <p style="text-align: right;">CT-TS-018437</p>

## Result

The oven’s language has been changed.

# How to Temporarily Change Temperature Units

## Background

This procedure is to allow a quick change between temperature units on the oven's display screen. The temperature unit will revert back to the original temperature units when oven power is cycled.

## Procedure

To temporarily change the temperature units, do the following.

Step	Action
1.	<b>Touch and hold</b> the menu icon ①. The temperature unit icon displays.
2.	<b>Touch</b> the temperature unit icon ②. <b>Repeat</b> the procedure to toggle between temperature units.

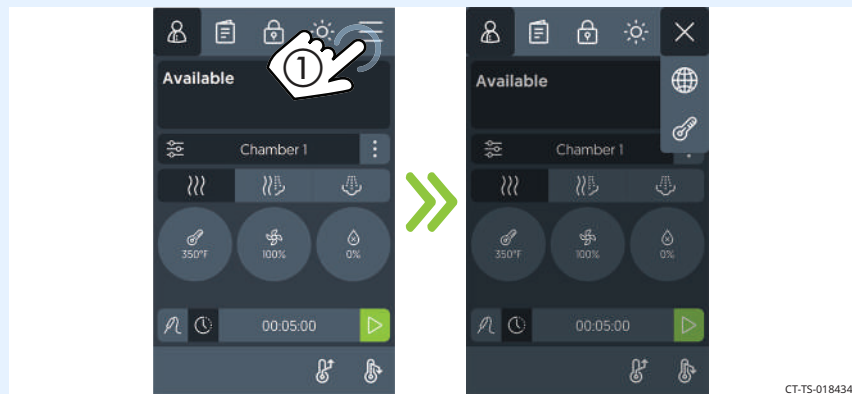

CT-TS-018434

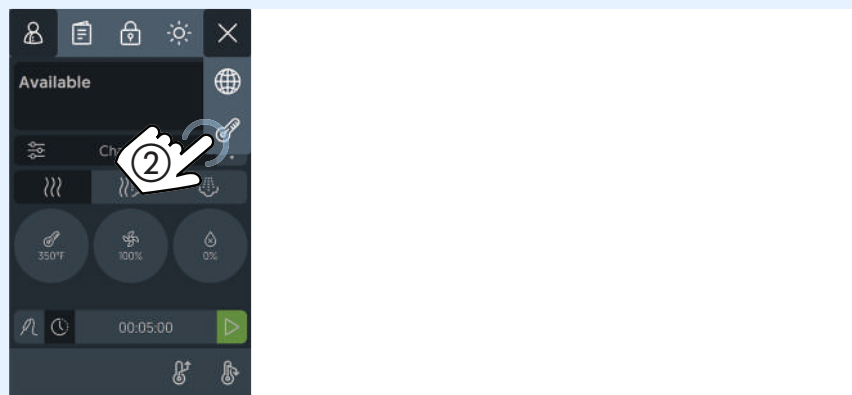

CT-TS-018443

## Result

The oven's language has been changed.

# How to Change the Home Screen

## Procedure

To change the home screen, do the following.

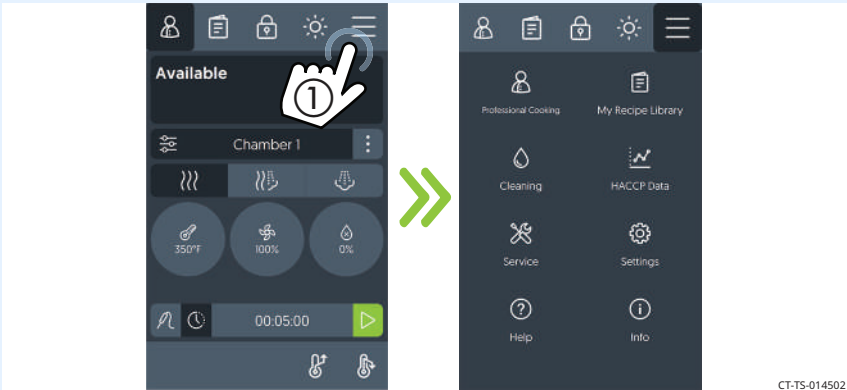
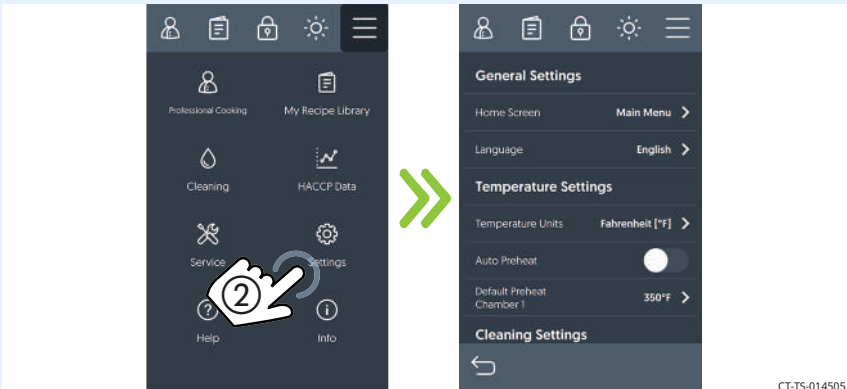
Step	Action
1.	<p><b>Touch</b> the menu icon ①. The menu screen displays.</p> 
2.	<p><b>Touch</b> the “Settings” icon ②. The “General Settings” screen displays.</p> 

*Continued on next page*

Continued from previous page

3. **Touch** the “Home Screen” setting ③. The select home screen menu displays.

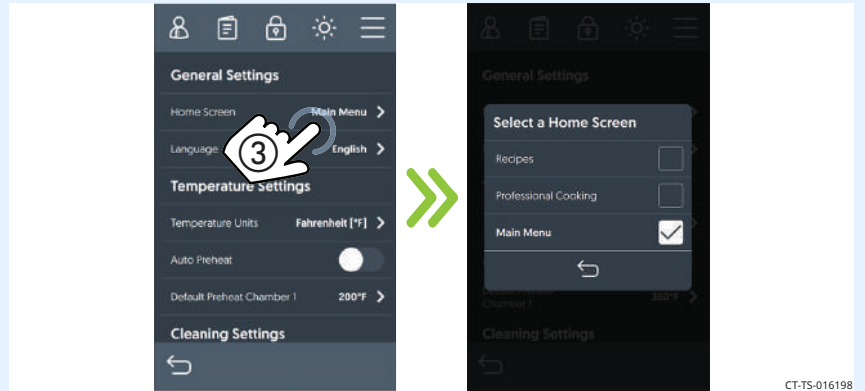

4. **Select** your desired home screen from the list.  
**Touch** the check mark ④ to save the home screen setting.

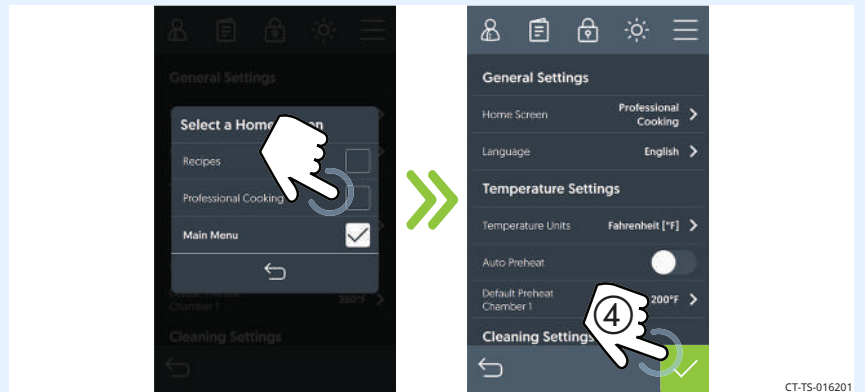

5. **Restart** the oven to reboot the home screen.

**Result**

The home screen has now been changed.

# How to Change the Temperature Scale

## Procedure

To change the temperature scale from °F to °C and vice versa, do the following.

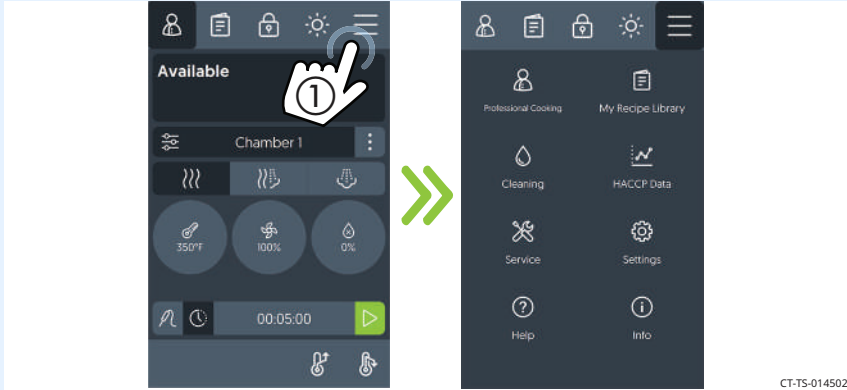
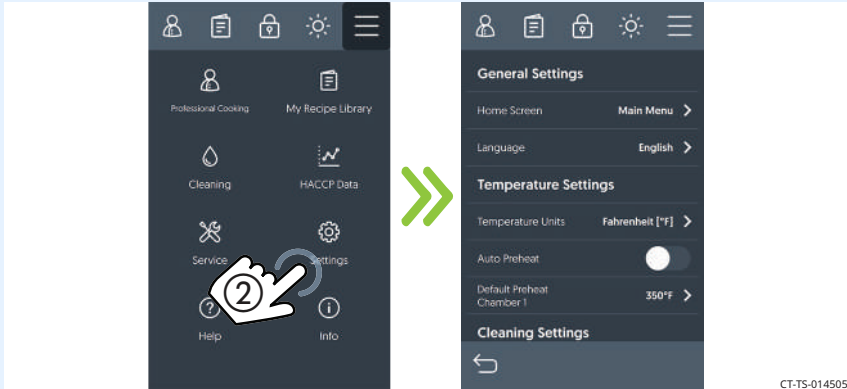
Step	Action
1.	<p><b>Touch</b> the menu icon ①. The menu screen displays.</p>  <p>CT-TS-014502</p>
2.	<p><b>Touch</b> the “Settings” icon ②. The “General Settings” screen displays.</p>  <p>CT-TS-014505</p>

*Continued on next page*

Continued from previous page

3. **Touch** the “Temperature Units” setting ③. The select temperature units screen displays.

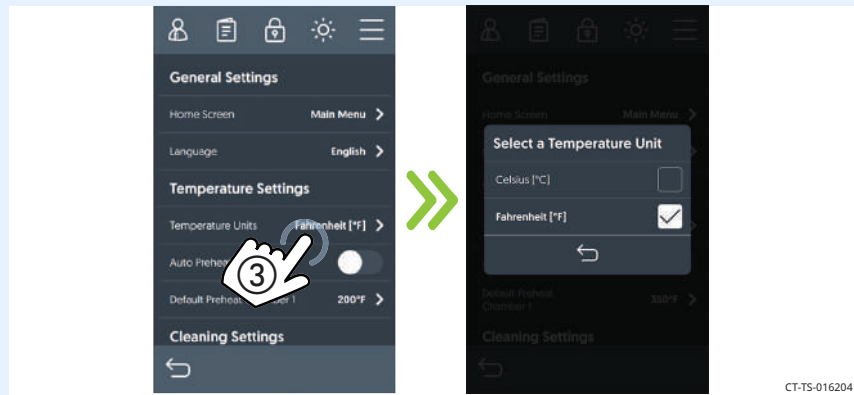

4. **Select** your desired temperature scale.  
**Touch** the check mark ④ to save the temperature scale setting.

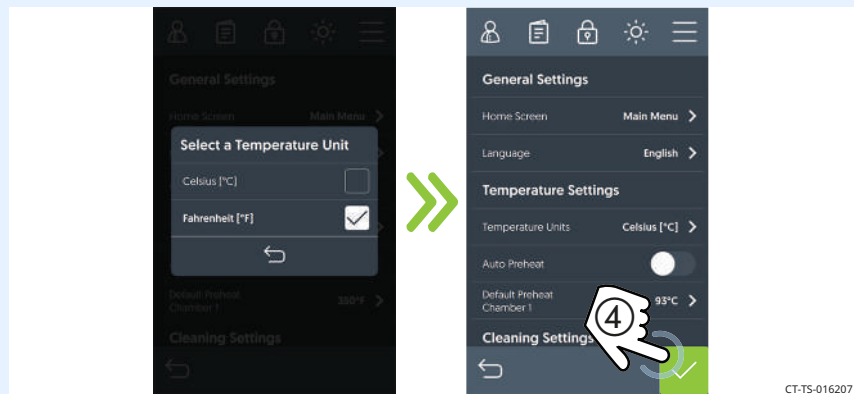

**Result**

The temperature scale has now been changed.

# How to Enable/Disable Automatic Preheat

## Background

Enabling the automatic preheat function preheats the oven upon start up to the set preheat temperature. Make sure to set your preheat temperatures. See topic *How to Preheat the Oven*.

## Procedure

To enable/disable automatic preheat, do the following.

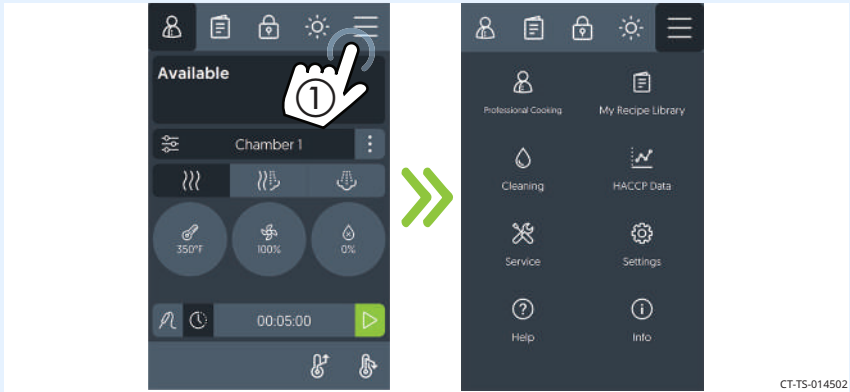
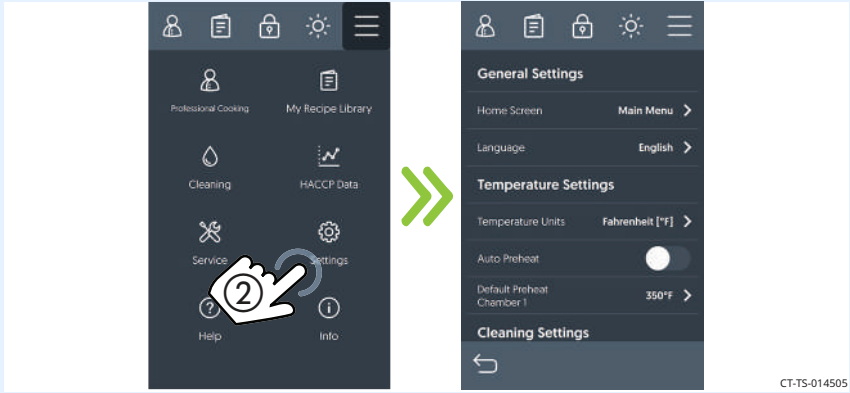
Step	Action
1.	<p><b>Touch</b> the menu icon ①. The menu screen displays.</p> 
2.	<p><b>Touch</b> the "Settings" icon ②. The "General Settings" screen displays.</p> 

*Continued on next page*

Continued from previous page

3. **Touch** the “Auto Preheat” button ③. **Touch** the check mark ④. The automatic preheat function is now enabled.

**Repeat** the process to disable the automatic preheat function.

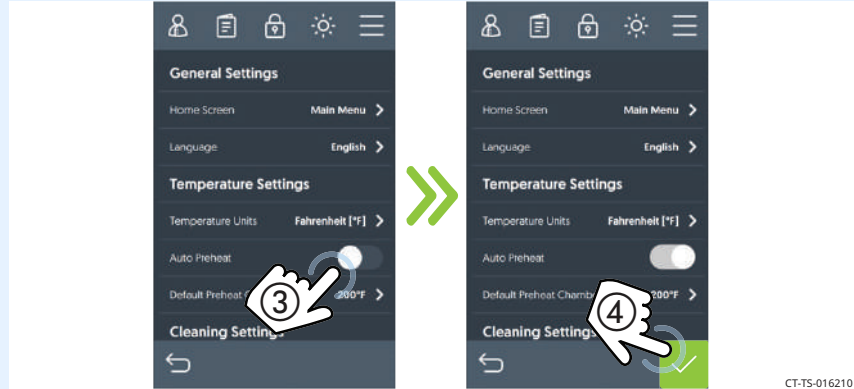

CT-TS-016210

**Result**

The automatic preheat function is now enabled/disabled.

# How to Change the Cooking Complete Notification Sound

## Background

When a cooking process is complete, the oven sounds an alert. This alert sound can be changed using the settings menu.

## Procedure

To change the cooking complete notification sound, do the following.

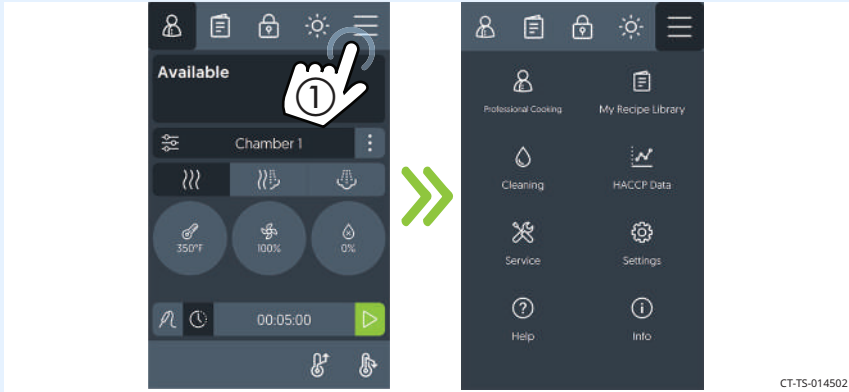
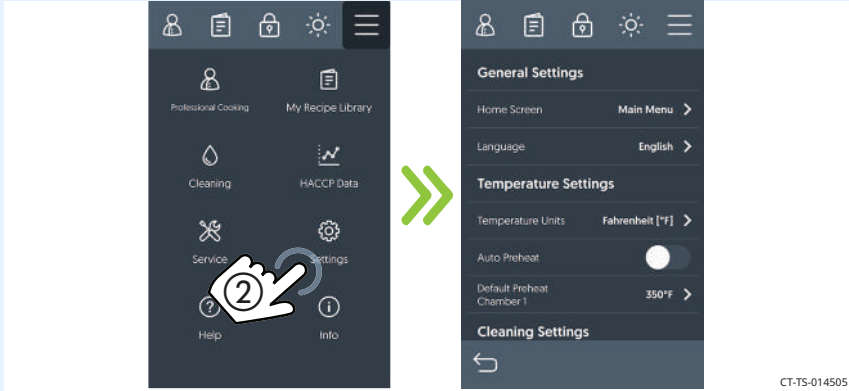
Step	Action
1.	<p><b>Touch</b> the menu icon ①. The menu screen displays.</p>  <p style="text-align: right;">CT-TS-014502</p>
2.	<p><b>Touch</b> the "Settings" icon ②. The "General Settings" screen displays.</p>  <p style="text-align: right;">CT-TS-014505</p>

*Continued on next page*

Continued from previous page

3. **Scroll** to “Sound & Light Alerts.”

**Touch** the “Done Sound” ③ setting. The “Select Sound” screen displays.

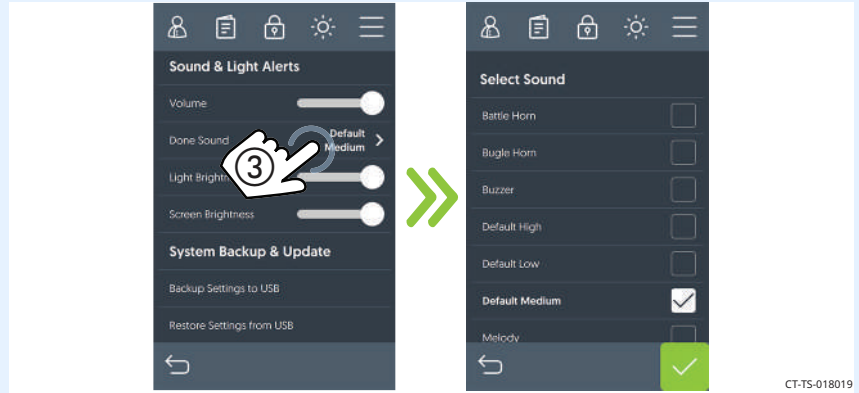

4. **Select** your desired notification sound from the list. **Touch** the check mark ④.

**NOTE:** Touching a different sound option will play a sample sound.

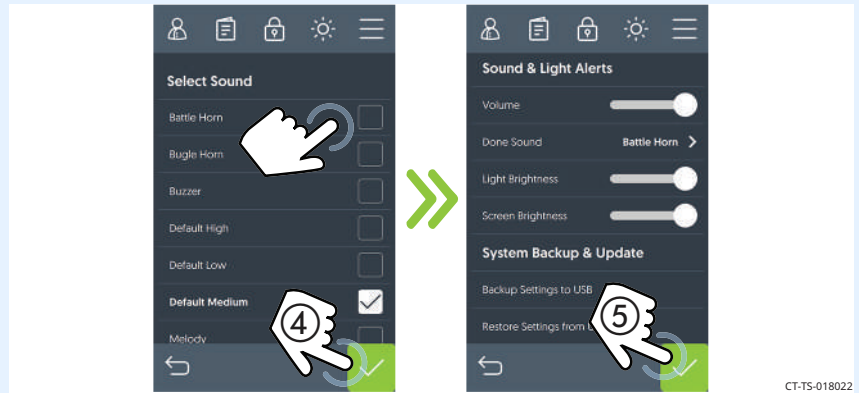

5. **Touch** the check mark ⑤ to save the setting.

**Result**

The cooking complete notification sound has now been changed.

# How to Lock Recipe Editing, the Settings Screen, or Auto Screen Lock

## Procedure

To lock recipe editing, the settings screen, or auto screen lock, do the following.

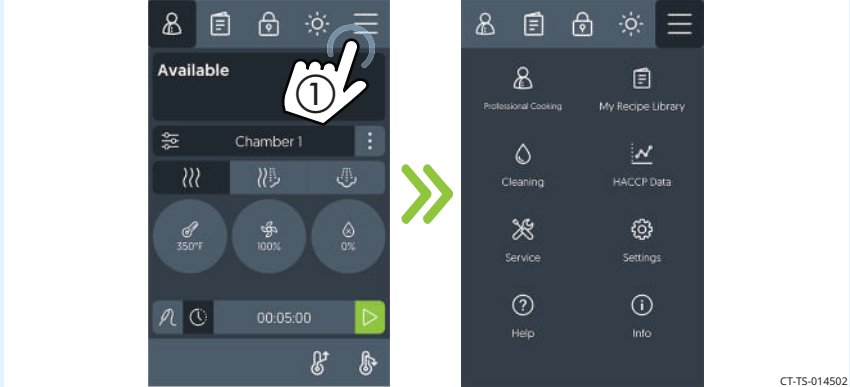
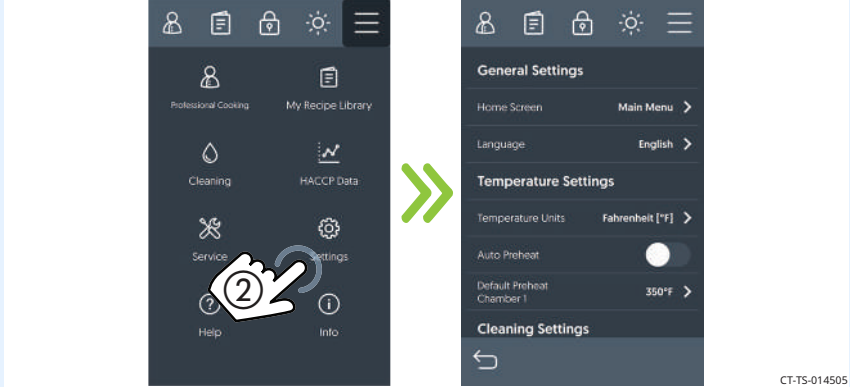
Step	Action
1.	<p><b>Touch</b> the menu icon ①. The menu screen displays.</p>  <p>The first screenshot shows the main control interface with a hand icon pointing to the menu icon (three horizontal lines) in the top right corner. A green arrow points to the right, leading to the next screenshot.</p> <p>The second screenshot shows the menu screen with various options: Professional Cooking, My Recipe Library, Cleaning, HACCP Data, Service, Settings, Help, and Info. The 'Settings' icon is highlighted with a hand icon and a circled '2'.</p> <p>CT-TS-014502</p>
2.	<p><b>Touch</b> the “Settings” icon ②. The “General Settings” screen displays.</p>  <p>The first screenshot shows the menu screen with various options: Professional Cooking, My Recipe Library, Cleaning, HACCP Data, Service, Settings, Help, and Info. The 'Settings' icon is highlighted with a hand icon and a circled '2'.</p> <p>The second screenshot shows the 'General Settings' screen with sections for General Settings, Temperature Settings, and Cleaning Settings. The 'Settings' icon is highlighted with a hand icon and a circled '2'.</p> <p>CT-TS-014505</p>

*Continued on next page*

Continued from previous page

3. **Scroll** to the “Security Locks.”

**Touch** the Lock Recipe Editing button ③. The “Enter passcode” screen displays.

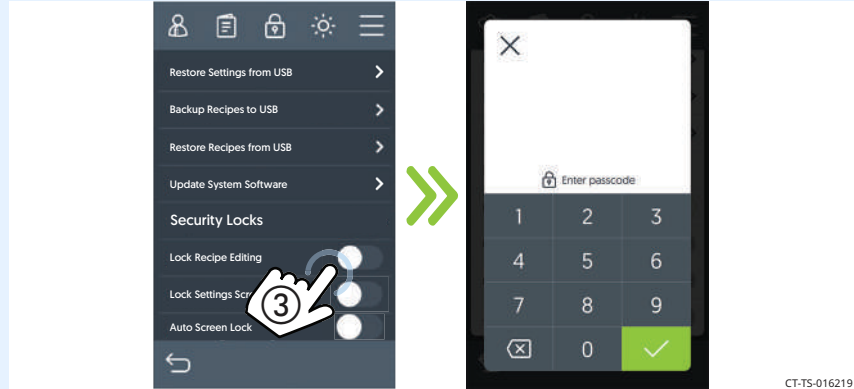

4. **Create** a passcode ④ using the keypad. **Touch** the check mark ⑤.

**Touch** the check mark ⑥ to lock recipe editing.

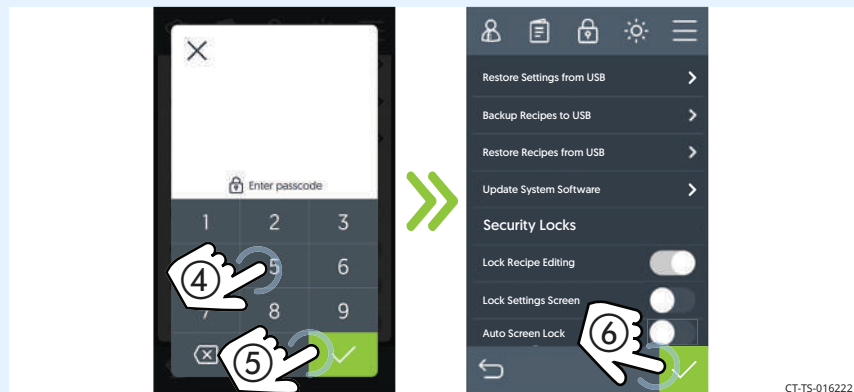

5. **Repeat** the process to lock the settings screen or auto screen lock.

**Result**

The procedure is now complete.

# How to View Oven Information

## Background

The oven information screen shows the oven model, serial number, software version, and system information.

## Procedure

To view oven information, do the following.

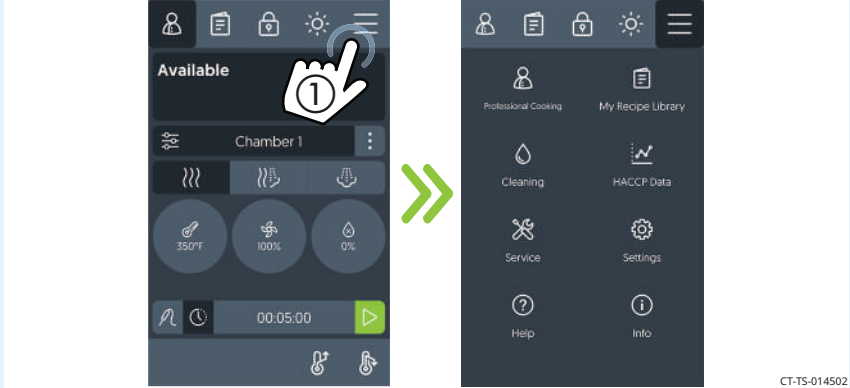
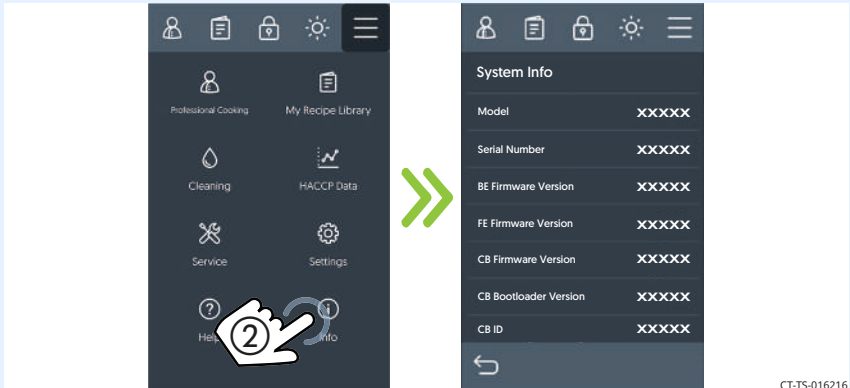
Step	Action
1.	<p><b>Touch</b> the menu icon ①. The menu screen displays.</p>  <p style="text-align: right;">CT-TS-014502</p>
2.	<p><b>Touch</b> the "Info" icon ②. The "System Info" screen displays.</p> <p><b>Scroll</b> to view the oven model, serial number, software version, and system information.</p>  <p style="text-align: right;">CT-TS-016216</p>

## Result

The oven's information has been viewed.

# How to Download HACCP Data

## Before you begin

### Make sure:

- The oven is on, but not in a cooking mode.
- You will need a USB drive.

## Background

HACCP data provides automated record keeping, set-point validation, recipes used, dates and times. The data is stored until the information is downloaded. Once downloaded, the information is removed from the oven's memory. Best practice would be to download the information every 30 days to a USB drive. The file format is plain text file (.csv). The file can be viewed in Microsoft® Excel.

## Procedure

To download HACCP data, do the following.

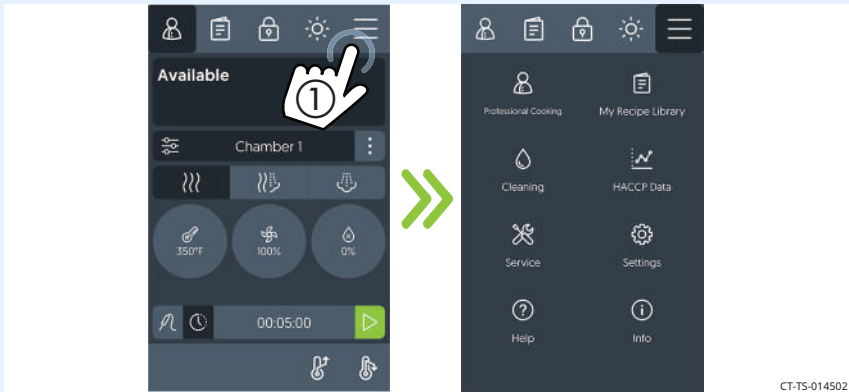
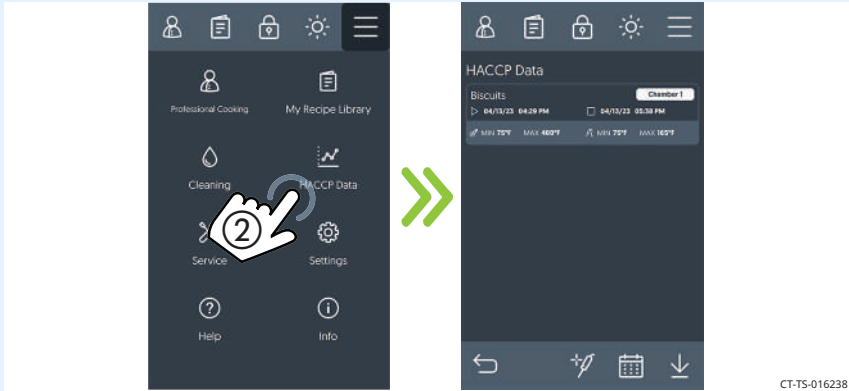
Step	Action
1.	<p><b>Touch</b> the menu icon ①. The menu screen displays.</p>  <p style="text-align: right;">CT-TS-014502</p>
2.	<p><b>Touch</b> the "HACCP Data" icon ②. The "HACCP Data" screen displays.</p>  <p style="text-align: right;">CT-TS-016238</p>

*Continued on next page*

Continued from previous page

3. **Plug** the USB drive ③ into the port.

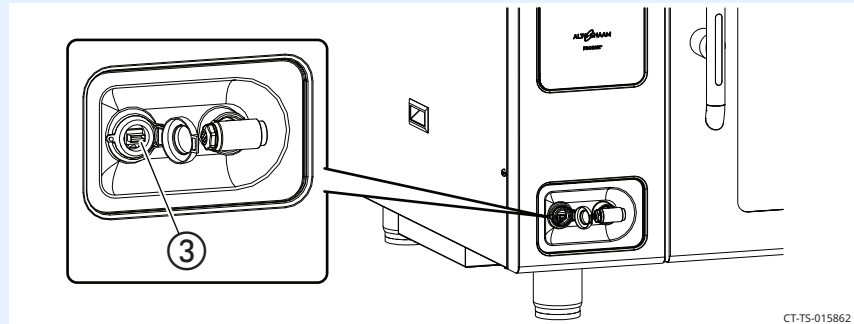

CT-TS-015862

4. **Touch** the download icon ④.

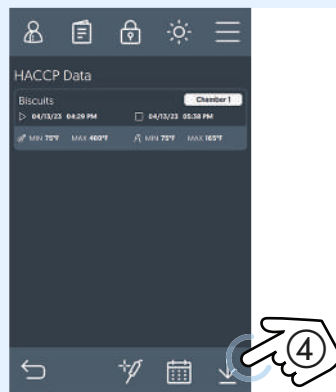

CT-TS-016241

## Loading the data

The oven downloads the data onto the USB drive. When the process is complete, the "Download Successful" screen displays. **Touch** the check mark to return to the menu screen. **Remove** the USB drive.

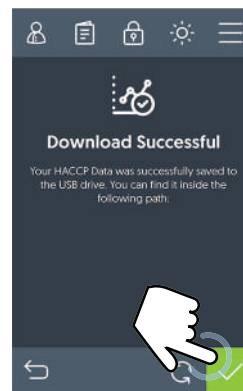

CT-TS-016244

## Result

The HACCP data has now been downloaded.

# How to Calibrate the Temperature Probe

## Before you begin

### Make sure:

- The oven is on, but not in cooking mode.
- You have a thermometer.
- You have a container filled with ice and water.

## Procedure

To calibrate the probe, do the following.

Step	Action
1.	<b>Insert</b> the probe and the thermometer in a container of ice water and allow the temperature to settle to 32°F (0°C).
2.	<b>Touch</b> the menu icon ①. The menu screen displays.
3.	<b>Touch</b> the “HACCP Data” icon ②. The “HACCP Data” screen displays.



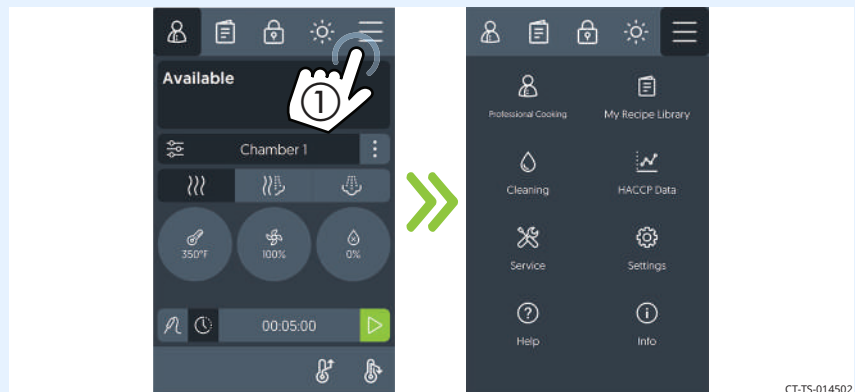

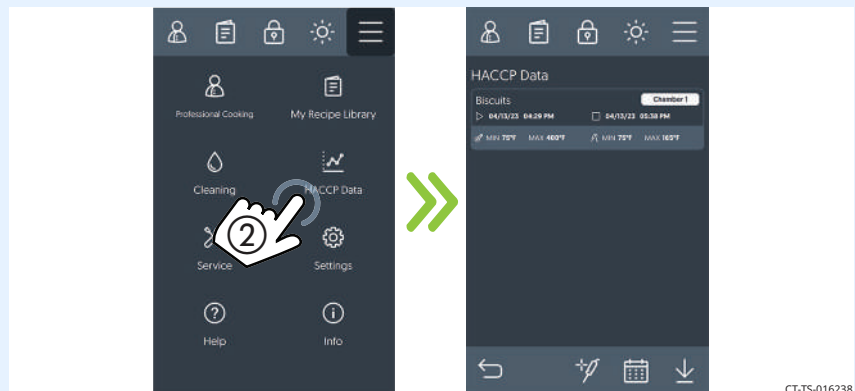

*Continued on next page*

Continued from previous page

4. **Touch** the calibrate probes icon ③.

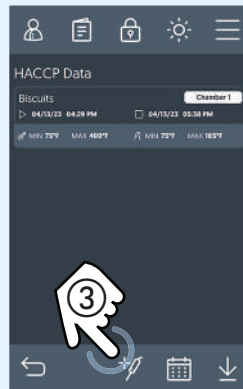

CT-TS-016272

5. **Compare** the probe temperature reading against 32°F (0°C).  
**Touch** the "+" or "-" symbols ④ until the temperature displayed is 32°F (0°C).

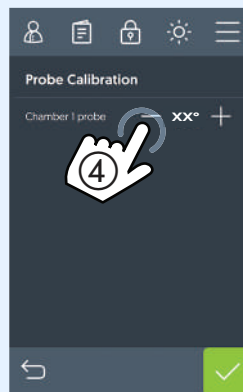

CT-TS-016275

6. **Remove** the probe from the ice water.

## Result

The probe is now calibrated.

This page is intentionally left blank.

# Maintenance Schedule

## Requirements

- See topic *How to Clean the Oven*.
- Make sure the oven is cooled down and off—inside of chamber 140°F (60°C) or less.

## Daily

For daily maintenance, do the following.

- **Remove** any spills with disposable paper wipes or a damp cloth.
- **Wipe** the outside of the oven with a damp cloth.
- **Wipe** the oven gaskets with soap and water.
- **Inspect** the oven gaskets for damage.
- **Wipe** the front door glass.
- **Check** the product probe.
- **Check** the screen for cracking or peeling. Contact Technical Service if needed.

## Weekly

For weekly maintenance, do the following.

- **Clean** the entire oven. **Make sure** to use a non-abrasive nylon scrub pad.
- Do not spray the cleaner directly into the fan openings located in the rear of the oven.
- **Inspect** the door LEDs.
- **Inspect** the oven cavity for signs of grease/carbon buildup.
- **Check** behind the fan panel inside the oven cavity for signs of grease/carbon buildup.
- **Check** behind the fan panel inside the oven cavity for signs of scale buildup.
- **Inspect** the heat exchanger for any signs of major deformation. If there are signs of deformation, immediately remove from service and take corrective action.
- **Inspect** the heat exchanger for any loose/disconnected pipes or flanges. If pipes or flanges are loose/disconnected, immediately remove from service and take corrective action.
- **Inspect** the convection elements for signs of cracking, deformation, or damage.
- **Clean** the ventless hood grease filters (if ventless hood is equipped).

## Monthly

For monthly maintenance, do the following.

- **Clean** out the drip tray line.
- **Check** the supplied water filtration and change as needed.
- **Check** for software updates.
- **Inspect** and test the proper draining of the oven cavity.
- **Inspect** the drain lines for leaks or clogs.

*Continued on next page*

*Continued from previous page*

- **Inspect** the oven cavity for any signs of scale buildup.
- **Inspect** the ventless hood paper filter (if ventless hood is equipped, replace as needed).
- **Test** the ventless hood drain for proper drainage and signs of leaking.
- **De-scale** as needed. See topic *How to Descale the Oven*.

## Yearly

For yearly maintenance, do the following.



**NOTE:** Must be performed by a qualified professional.

- **Replace** the steam bypass hose.
- **Inspect** and test the humidity control.
- **Inspect** the cleaning system pump and hoses for leaks and proper operation.
- **Inspect** and test the proper draining of the oven cavity.
- **Inspect** all steam water injection lines and clamps for leaks or potential issues.
- **Inspect** the hand shower handle and hose.
- **Test** steam injection solenoid.
- **Test** condensate solenoid.

- **Inspect** the upper browning valve hose.
- **Inspect** the low pressure relief valve and hose.
- **Inspect** the convection element seal from the electrical compartment.
- **Inspect** the gas heat exchanger seal from the electrical compartment.
- **Inspect** wiring to heating elements. Re-tighten or secure as needed. Record the amp draw.
- **Inspect** the N6 oven temperature probe seal.
- **Check** operation of all electrical cooling fans.
- **Check** all electrical connections are properly connected and secure to the boards.

- **Check** door hinges and handles. Tighten, secure, or adjust as needed.
- **Run** the oven in convection mode and test operation.
- **Run** the oven in steam mode and test operation.

# How to Clean the Oven using Cleaning Tablets

## Precautions



**WARNING:** Burn hazard.

Wear protective gloves, protective clothing, eye protection, and face protection when handling oven cleaner. Do not open the oven door during the cleaning cycle.

**NOTICE**

Do not use steel pads, wire brushes, or scrapers when cleaning.

## Background

The oven has five different cleaning modes.

- The rinse cycle (10 minutes).
- The light clean cycle (35 minutes).
- The medium clean cycle (1 hour and 18 minutes).
- The heavy clean cycle (2 hours and 5 minutes).
- The heavy plus clean cycle (3 hours and 30 minutes).

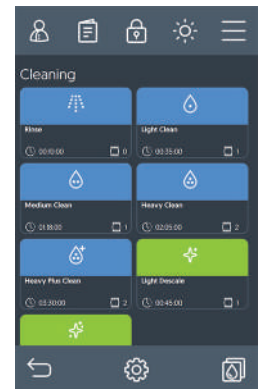

CT-15-014567

## Cleaning the oven

To clean the oven, do the following.

Step	Action
1.	<b>Clean</b> the door glass with Windex® or equivalent glass cleaner.
2.	<b>Clean</b> the door gasket with soap and water.
3.	<p><b>Close</b> the door.</p> <p><b>Spray</b> the exterior of the oven with stainless steel polish. <b>Wipe</b> the exterior of the oven with a non-abrasive scrub pad. Follow safety instructions on the bottle of the stainless steel polish.</p> <div style="border: 1px solid blue; padding: 5px; margin-top: 10px;"> <p><b>NOTICE</b> Use only non-caustic cleaners.</p> <p>Do not spray directly into the fan openings on the rear of the oven.</p> <p>Do not use cleaners that contain sodium hydroxide (lye) or phosphorus.</p> </div>

*Continued on next page*

Continued from previous page

4. **Touch** the menu icon ①. The menu screen displays.

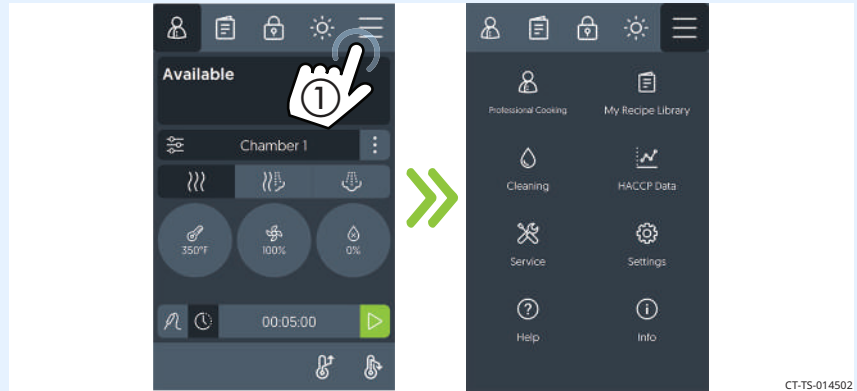

5. **Touch** the "Cleaning" icon ②. The Cleaning screen displays.

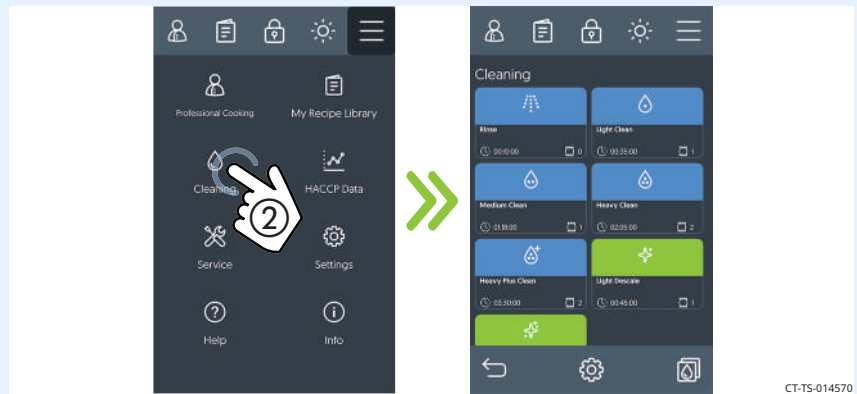

Continued on next page

Continued from previous page

6. **Select** the desired cleaning level, for example Heavy Clean ③.

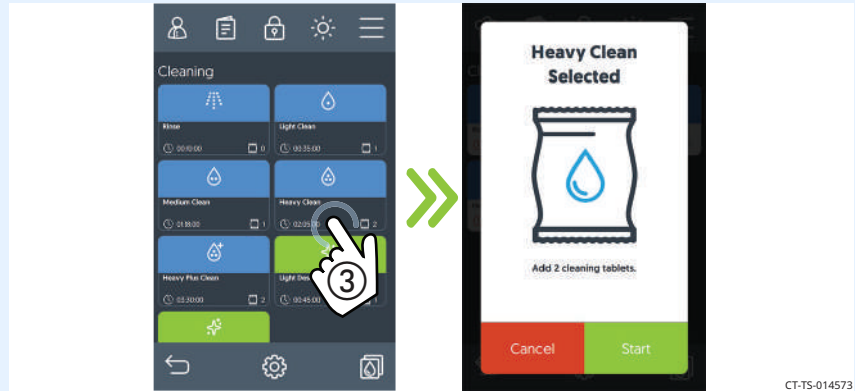

CT-TS-014573

**Insert** the appropriate number of cleaning tablets into the drain.

**Close** the drain screen.

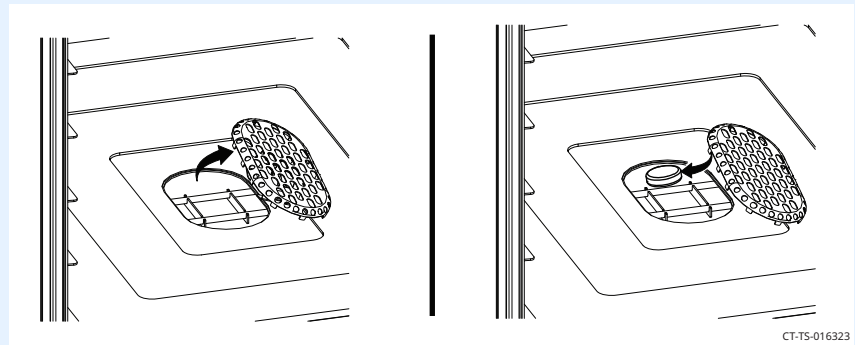

CT-TS-016323

7. **Touch** the "Start" icon ④.

**NOTE:** If needed, touch the cancel icon to stop the cleaning process. The cancel option is available for five seconds.

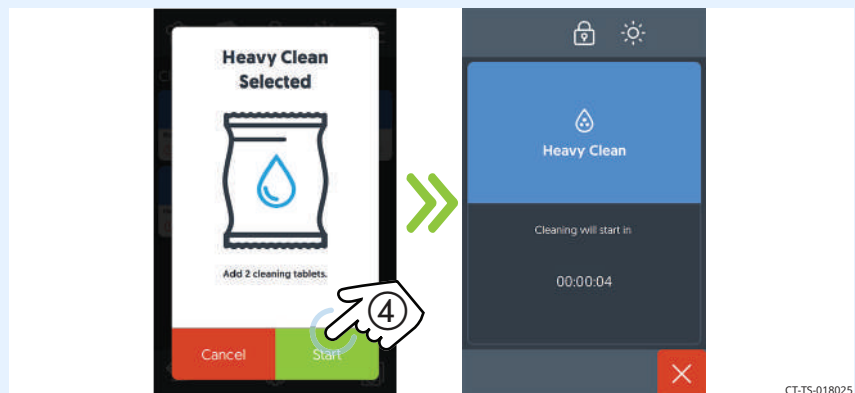

CT-TS-018025

Continued on next page

Continued from previous page

- The oven heats to the required temperature for the cleaning cycle, then the cleaning cycle starts.

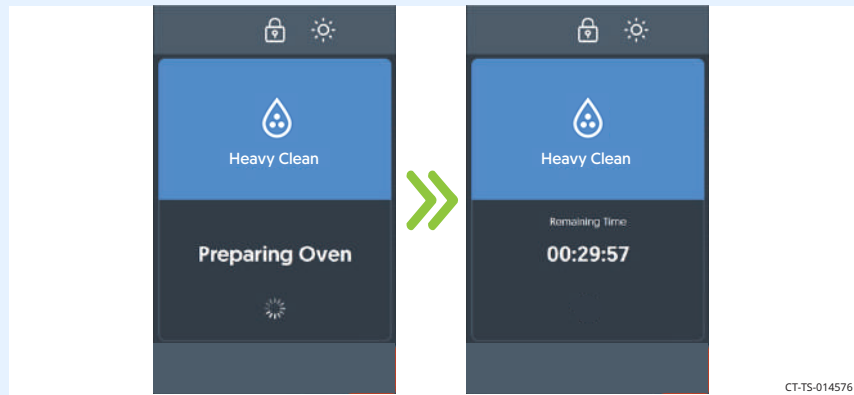

- Touch "Ok" ⑤** when the cleaning cycle is complete.



**WARNING:** Burn hazard.

Open the door carefully when the cleaning cycle is complete. Escaping hot vapors or steam can cause injury.

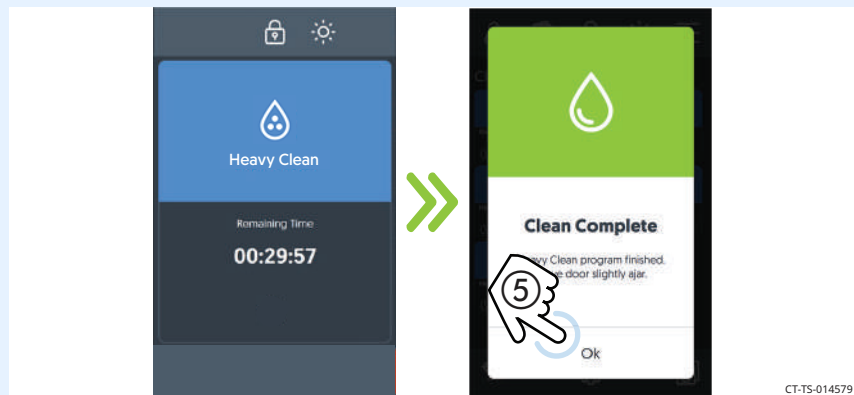

- Leave** the door slightly ajar if the cleaning has been done at the end of the day.



**NOTE:** The oven stays idle for a few minutes before turning off.

**Result**

The oven is now clean.

# How to Descal the Oven

## Before you begin



**WARNING:** Burn hazard.

Wear protective gloves, protective clothing, eye protection, and face protection when handling oven cleaner. Do not open the oven door during the wash or rinse cycle.

**NOTICE**

Do not use steel pads, wire brushes, or scrapers when cleaning.

**Make sure** you have Alto-Shaam Descaling Tablets (CE-49674).

## Background

The oven has two different descaling modes.

- The light descale cycle (45 minutes).
- The heavy descale cycle (1 hour and 40 minutes).

## Procedure

To descale the oven, do the following.

Step	Action
1.	<p><b>Touch</b> the menu icon ①. The menu screen displays.</p>

CT-TS-014502

*Continued on next page*

Continued from previous page

2. **Touch** the “Cleaning” icon ②. The Cleaning screen displays.

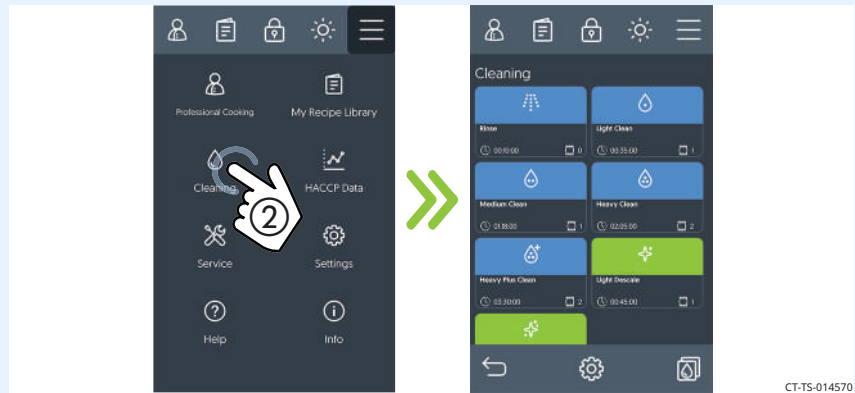

CT-TS-014570

3. **Select** the desired descaling level, for example Heavy Descale ③.

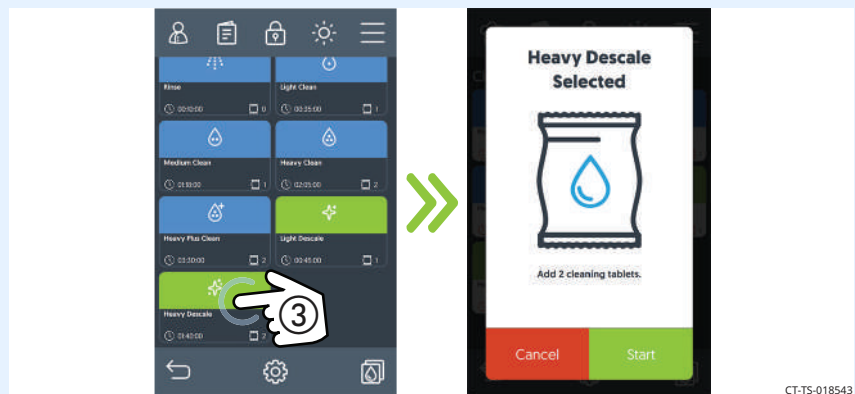

CT-TS-018543

**Insert** the appropriate number of descaling tablets into the drain.

**Close** the drain screen.

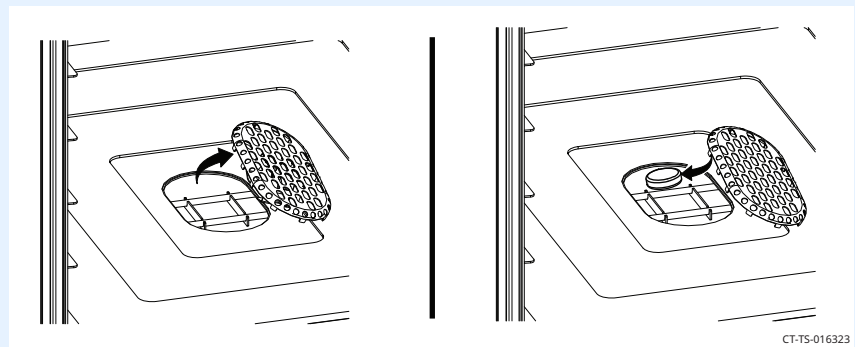

CT-TS-016323

Continued on next page

Continued from previous page

4. **Touch** the “Start” icon ④.

**NOTE:** If needed, touch and hold the cancel icon to stop the descaling process. The cancel option is available for five seconds.

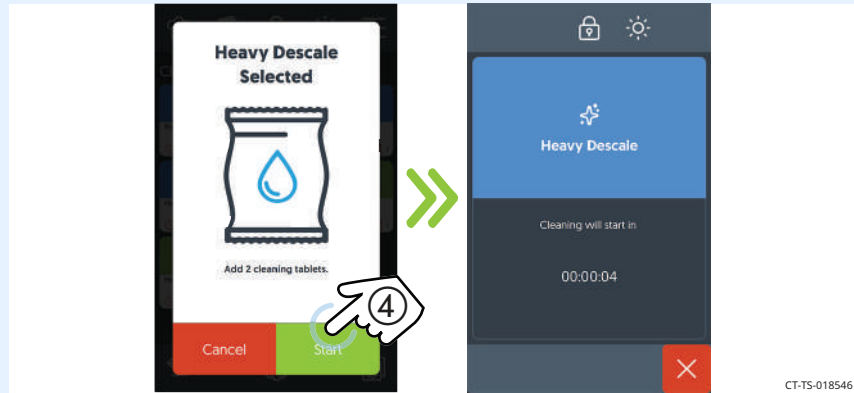

5. The oven heats to the required temperature for the descaling cycle, then the descale cycle starts.

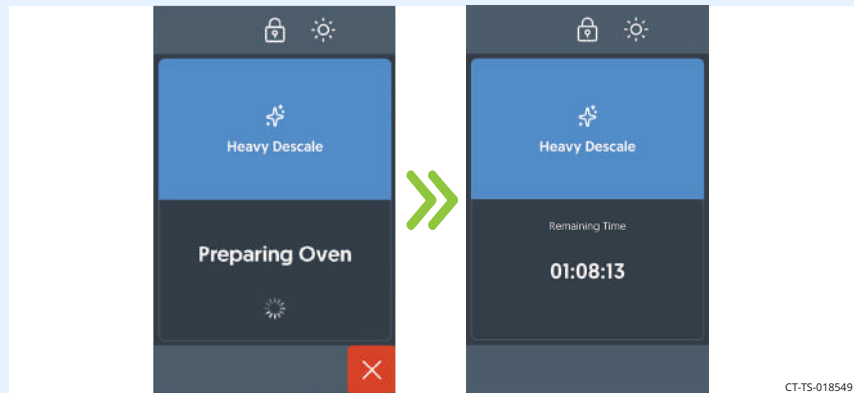

Continued on next page

Continued from previous page

6. **Touch "Ok"** ⑤ when the descaling cycle is complete.



**WARNING:** Burn hazard.

Open the door carefully when the descaling cycle is complete. Escaping hot vapors or steam can cause injury.

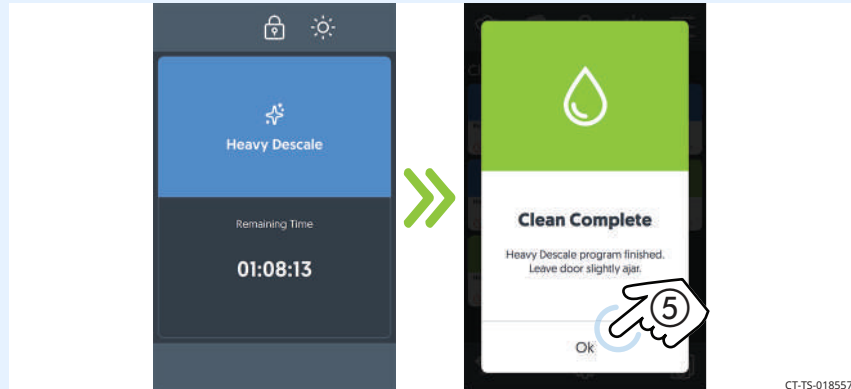

7. If necessary, **open** the interior fan guard and rinse down the area behind the panel.
8. **Leave** the door slightly ajar if the descaling has been done at the end of the day.



**NOTE:** The oven stays idle for a few minutes before turning off.

**Result**

The oven is now descaled.

# How to View the Cleaning Log

## Background

The cleaning log allows the user to view details about the previously completed cleaning cycles on the unit.

## Procedure

To view the cleaning log, do the following.

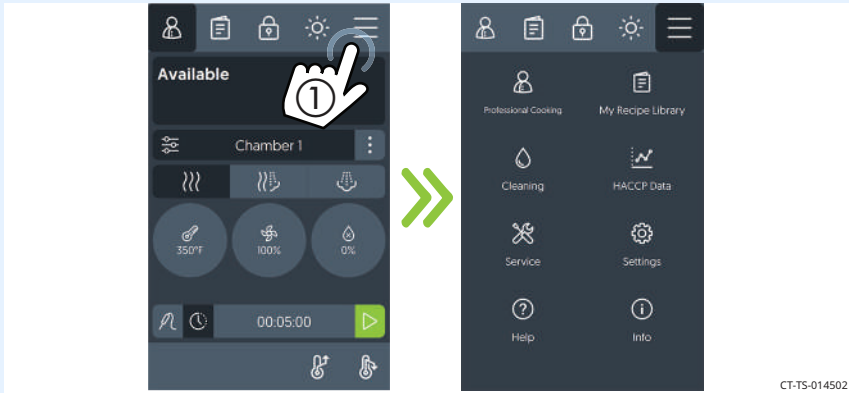
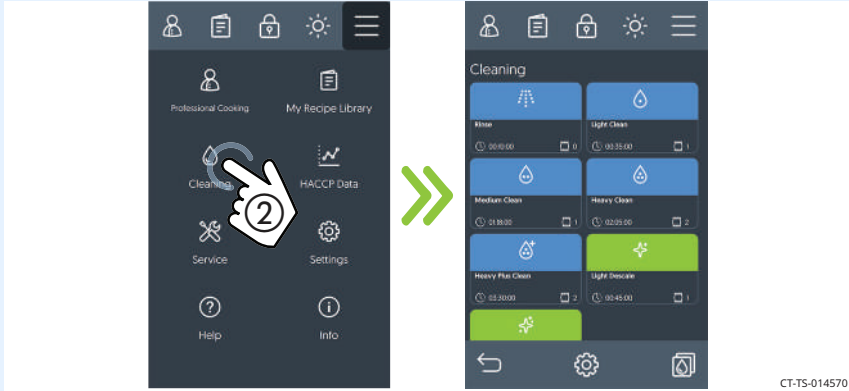
Step	Action
1.	<p><b>Touch</b> the menu icon ①. The menu screen displays.</p>  <p>CT-TS-014502</p>
2.	<p><b>Touch</b> the "Cleaning" icon ②. The "Cleaning" screen displays.</p>  <p>CT-TS-014570</p>

*Continued on next page*

Continued from previous page

3. **Touch** the cleaning log icon ③. The “Cleaning log” screen displays.

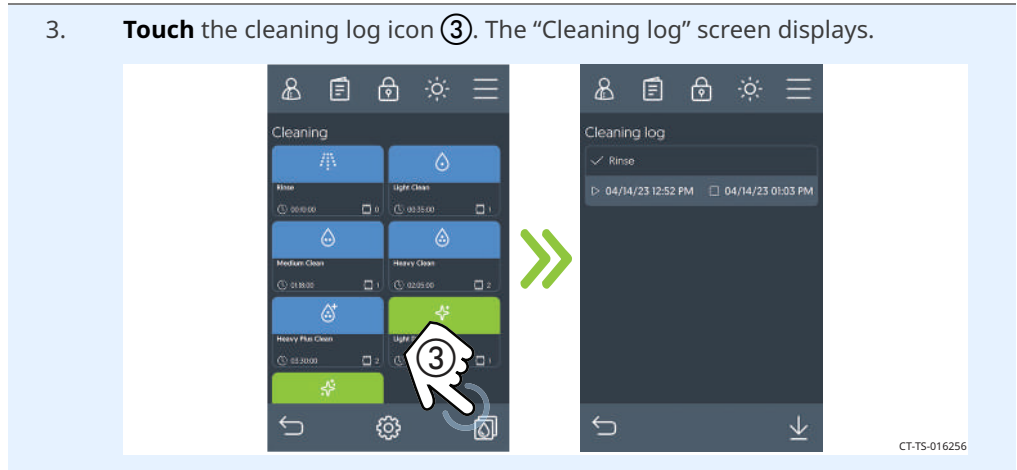

**Result**

The cleaning log has been viewed.

# How to Set the Cleaning Frequency

## Background

The user can set a cleaning frequency to schedule when the unit will go through a cleaning cycle. The cleaning frequency can be set by hours or day and time.

## Procedure

To set the cleaning time, do the following.

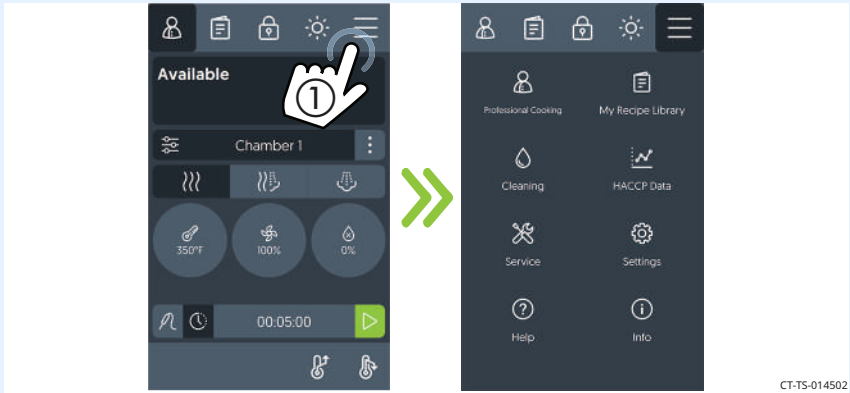
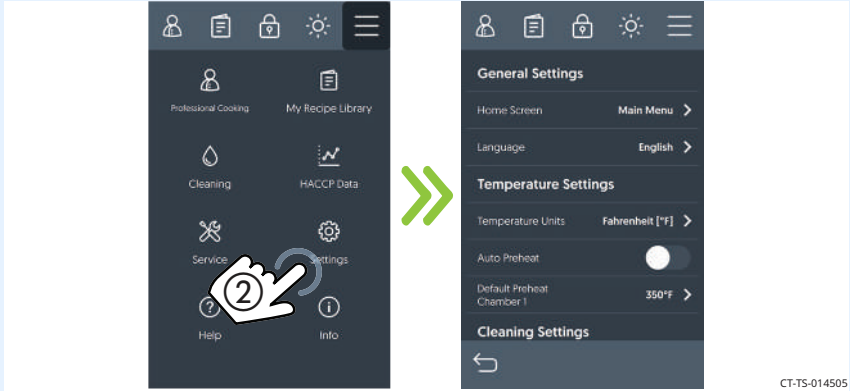
Step	Action
1.	<p><b>Touch</b> the menu icon ①. The menu screen displays.</p>  <p>CT-TS-014502</p>
2.	<p><b>Touch</b> the “Settings” icon ②. The “General Settings” screen displays.</p>  <p>CT-TS-014505</p>

*Continued on next page*

Continued from previous page

3. **Scroll** ③ until "Cleaning Settings" displays. **Touch** the "Set Cleaning Frequency" ④ setting.

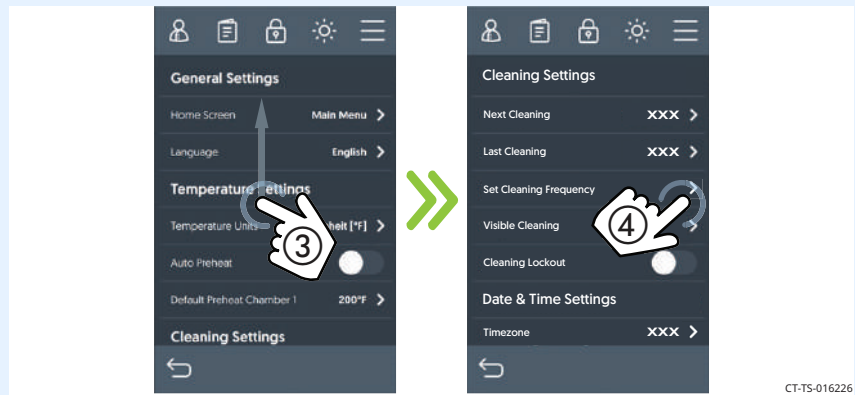

CT-TS-016226

**Setting the cleaning frequency hours**

4. **Touch** the "Hours" setting ⑤ to set the cleaning frequency hours. **Enter** the desired hours using the key pad. **Touch** the check mark.

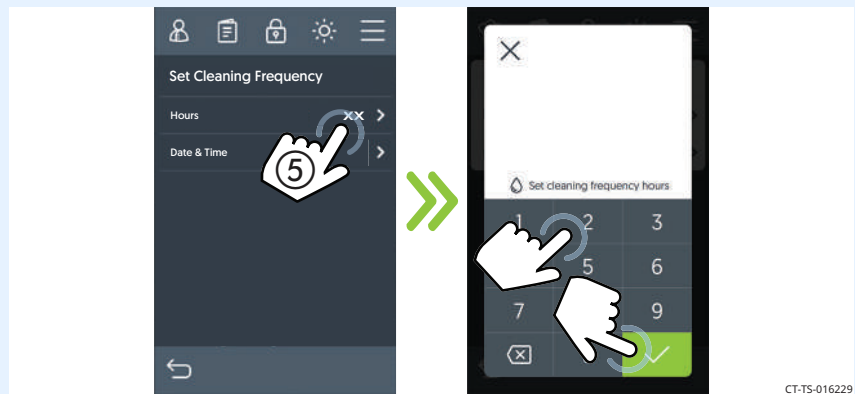

CT-TS-016229

**Setting the cleaning frequency day and time**

5. **Touch** the "Date & Time" setting ⑥ to set the day and time for cleaning. **Touch** the check box ⑦ next to a day to set it. **Touch** the check mark.

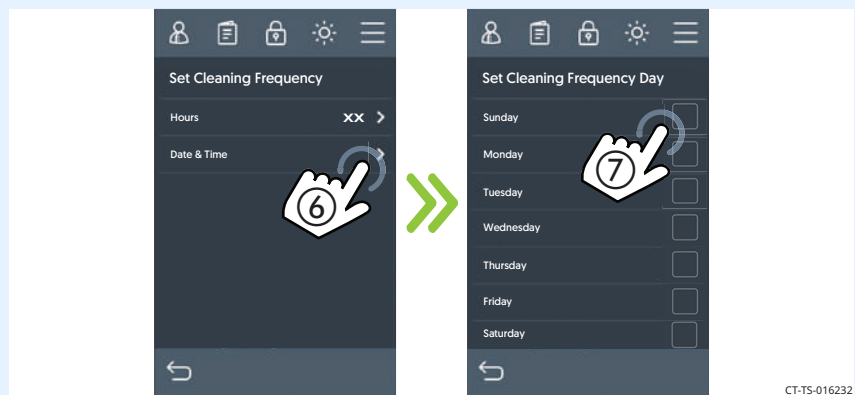

CT-TS-016232

Continued on next page

Continued from previous page

- The "Set cleaning frequency time" screen will display.  
**Touch** the "AM"/"PM" button ⑧ to choose whether the cleaning time is set for AM or PM.  
**Enter** the time of day for the cleaning. **Touch** the check mark.  
**Touch** the check mark on the "Set Cleaning Frequency" setting screen.

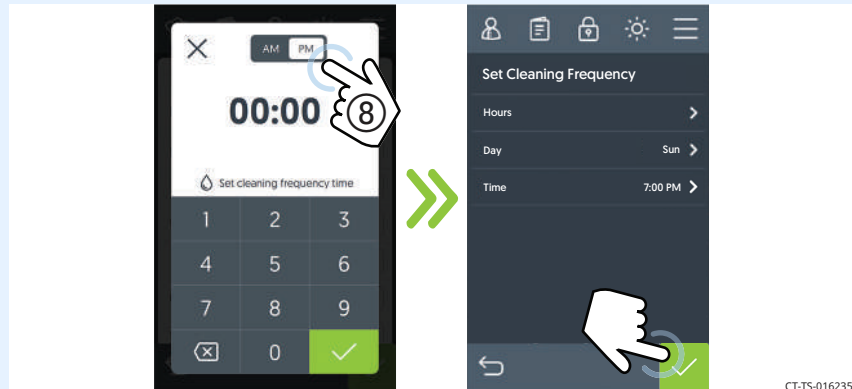

## Result

The cleaning frequency has been set.

# How to Winterize the Oven

## Winterization

Winterization is required if the oven is stored in a location where the ambient temperature falls below 32°F (0°C). Freezing temperatures can permanently damage internal components, especially if water is not completely drained from the unit before storage.

## Winterize the oven

To winterize the oven, do the following.

Step	Action
1.	Allow the oven to cool.
2.	<b>Drain</b> all hoses, solenoids, and tanks (condensate and pump housing).
3.	<b>Flush</b> RV antifreeze through the tanks and hoses.
<div style="display: flex; align-items: center;">  <div> <p><b>WARNING:</b> Poison hazard.</p> <p>Use only RV antifreeze specifically intended for potable water systems. Flush system thoroughly as directed before putting back into use.</p> </div> </div>	
4.	<b>Inspect</b> all hoses, and components connected to hoses, for signs or cracking or splitting.
5.	<b>Flush</b> cold water through each hose and each solenoid for a minimum of two minutes.
6.	<b>Spray</b> cold water directly into oven cavity drain for a minimum of two minutes.
<div style="display: flex; align-items: center;"> <div style="background-color: #0056b3; color: white; padding: 2px 5px; margin-right: 10px;"><b>NOTICE</b></div> <p>Do not use pressurized water for this step. Use only the oven's hand shower.</p> </div>	
7.	<b>Run</b> a forced rinse cycle.
8.	<b>Inspect</b> drained water to verify all RV antifreeze has been flushed through all hoses and tanks.
9.	<b>Run</b> a 30-minute steam cycle and 30-minute clean cycle.

## Restart the oven

## Result

The oven is now ready for operation.

# Error Codes

Code	Component	Description	Troubleshooting steps
E-5	2 - Convection fan	Convection fan (upper) under speed	<ol style="list-style-type: none"> <li>1. Power down control using on/off icon.</li> <li>2. Cycle power to the oven either by unplugging the unit or by turning the main power switch off and then back on.</li> <li>3. Resume use of oven. If error reappears contact a service provider.</li> </ol>
E-5	2 - Convection fan	Lower convection fan under speed	<ol style="list-style-type: none"> <li>1. Power down control using on/off icon.</li> <li>2. Cycle power to the oven either by unplugging the unit or by turning the main power switch off and then back on.</li> <li>3. Resume use of oven. If error reappears contact a service provider.</li> </ol>
E-10	44 - Cavity sensor	Cavity sensor short	<ol style="list-style-type: none"> <li>1. Power down control using on/off icon.</li> <li>2. Cycle power to the oven either by unplugging the unit or by turning the main power switch off and then back on.</li> <li>3. Resume use of oven. If error reappears contact a service provider.</li> </ol>
E-10	47 - Food probe	Food probe short	<ol style="list-style-type: none"> <li>1. Investigate food probe for damage. Replace if damaged.</li> <li>2. Power down control using on/off icon.</li> <li>3. Cycle power to the oven either by unplugging the unit or by turning the main power switch off and then back on.</li> <li>4. Resume use of oven. If error reappears contact a service provider.</li> </ol>
E-10	52 - Steam injector	Steam injector sensor short	<ol style="list-style-type: none"> <li>1. Power down control using on/off icon.</li> <li>2. Cycle power to the oven either by unplugging the unit or by turning the main power switch off and then back on.</li> <li>3. Resume use of oven. If error reappears contact a service provider.</li> </ol>
E-10	55 - Tank	Tank sensor short	<ol style="list-style-type: none"> <li>1. Power down control using on/off icon.</li> <li>2. Cycle power to the oven either by unplugging the unit or by turning the main power switch off and then back on.</li> <li>3. Resume use of oven. If error reappears contact a service provider.</li> </ol>
E-11	44 - Cavity sensor	Cavity sensor open	<ol style="list-style-type: none"> <li>1. Power down control using on/off icon.</li> <li>2. Cycle power to the oven either by unplugging the unit or by turning the main power switch off and then back on.</li> <li>3. Resume use of oven. If error reappears contact a service provider.</li> </ol>

Code	Component	Description	Troubleshooting steps
E-11	52 - Steam injector	Steam injector sensor open	<ol style="list-style-type: none"> <li>1. Power down control using on/off icon.</li> <li>2. Cycle power to the oven either by unplugging the unit or by turning the main power switch off and then back on.</li> <li>3. Resume use of oven. If error reappears contact a service provider.</li> </ol>
E-11	55 - Tank	Tank sensor open	<ol style="list-style-type: none"> <li>1. Power down control using on/off icon.</li> <li>2. Cycle power to the oven either by unplugging the unit or by turning the main power switch off and then back on.</li> <li>3. Resume use of oven. If error reappears contact a service provider.</li> </ol>
E-31	2 - Convection fan (Classic control)	Motor (upper) over temperature	<ol style="list-style-type: none"> <li>1. Power down control using on/off icon.</li> <li>2. Cycle power to the oven either by unplugging the unit or by turning the main power switch off and then back on.</li> <li>3. Resume use of oven. If error reappears contact a service provider.</li> </ol>
E-31	2 - Convection fan (Classic control)	Lower motor over temperature	<ol style="list-style-type: none"> <li>1. Power down control using on/off icon.</li> <li>2. Cycle power to the oven either by unplugging the unit or by turning the main power switch off and then back on.</li> <li>3. Resume use of oven. If error reappears contact a service provider.</li> </ol>
E-31	2 - Convection fan	Motor VFD (upper) over temperature	<ol style="list-style-type: none"> <li>1. Make sure cooling fan(s) are operating.</li> <li>2. Make sure exhaust vents are clean and free of debris.</li> <li>3. Make sure oven clearances are met.</li> <li>4. Ambient temperature greater than 105°F (41°C).</li> </ol>
E-31	2 - Convection fan	Lower motor VFD over temperature	<ol style="list-style-type: none"> <li>1. Make sure cooling fan(s) are operating.</li> <li>2. Make sure exhaust vents are clean and free of debris.</li> <li>3. Make sure oven clearances are met.</li> <li>4. Ambient temperature greater than 105°F (41°C).</li> </ol>
E-31	44 - Cavity sensor	Chamber over temperature	<ol style="list-style-type: none"> <li>1. If the oven has experienced an over temperature condition allow the oven to cool down for a minimum of 30 minutes.</li> <li>2. Press the high limit reset button.</li> <li>3. Resume cooking operation. If error reappears contact service provider.</li> </ol>
E-31	55 - Tank	Tank sensor over temperature	<ol style="list-style-type: none"> <li>1. If the oven has experienced an over temperature condition allow the oven to cool down for a minimum of 30 minutes.</li> <li>2. Press the high limit reset button.</li> <li>3. Resume cooking operation. If error reappears contact service provider.</li> </ol>

Code	Component	Description	Troubleshooting steps
E-31	8 - Control Board	Control board too warm	<ol style="list-style-type: none"> <li>1. Make sure cooling fan(s) are operating.</li> <li>2. Make sure exhaust vents are clean and free of debris.</li> <li>3. Make sure oven clearances are met.</li> <li>4. Ambient temperature greater than 105°F (41°C).</li> <li>5. Check the door gasket for damage and proper seal.</li> </ol>
E-31	9 - Interface Board	Interface board too warm	<ol style="list-style-type: none"> <li>1. Make sure cooling fan(s) are operating.</li> <li>2. Make sure exhaust vents are clean and free of debris.</li> <li>3. Make sure oven clearances are met.</li> <li>4. Ambient temperature greater than 105°F (41°C).</li> <li>5. Check the door gasket for damage and proper seal.</li> </ol>
E-44	8 - Control Board	Control board SPI bus warning	<ol style="list-style-type: none"> <li>1. Touch screen to acknowledge error.</li> <li>2. Continue to use equipment.</li> <li>3. Cycle equipment power before attempting to update software.</li> <li>4. If error continues, contact service.</li> </ol>
E-55	56 - Vent valve	Vent (upper) not open	<ol style="list-style-type: none"> <li>1. Power down control using on/off icon.</li> <li>2. Cycle power to the oven either by unplugging the unit or by turning the main power switch off and then back on.</li> <li>3. Resume use of oven. If error reappears contact a service provider.</li> </ol>
E-55	56 - Vent valve	Lower vent valve not open	<ol style="list-style-type: none"> <li>1. Power down control using on/off icon.</li> <li>2. Cycle power to the oven either by unplugging the unit or by turning the main power switch off and then back on.</li> <li>3. Resume use of oven. If error reappears contact a service provider.</li> </ol>
E-62	2 - Convection fan	Motor VFD (upper) over current	<ol style="list-style-type: none"> <li>1. Power down control using on/off icon.</li> <li>2. Cycle power to the oven either by unplugging the unit or by turning the main power switch off and then back on.</li> <li>3. Resume use of oven. If error reappears contact a service provider.</li> </ol>
E-62	2 - Convection fan	Lower motor VFD over current	<ol style="list-style-type: none"> <li>1. Power down control using on/off icon.</li> <li>2. Cycle power to the oven either by unplugging the unit or by turning the main power switch off and then back on.</li> <li>3. Resume use of oven. If error reappears contact a service provider.</li> </ol>
E-66	2 - Convection fan	VFD (upper) error	<ol style="list-style-type: none"> <li>1. Power down control using on/off icon.</li> <li>2. Cycle power to the oven either by unplugging the unit or by turning the main power switch off and then back on.</li> <li>3. Resume use of oven. If error reappears contact a service provider.</li> </ol>

Code	Component	Description	Troubleshooting steps
E-66	2 - Convection fan	Lower VFD error	<ol style="list-style-type: none"> <li>1. Power down control using on/off icon.</li> <li>2. Cycle power to the oven either by unplugging the unit or by turning the main power switch off and then back on.</li> <li>3. Resume use of oven. If error reappears contact a service provider.</li> </ol>
E-78	19 - Voltage sensor	Voltage monitor too low	<ol style="list-style-type: none"> <li>1. Check to make sure the unit plug is fully seated in the electrical outlet.</li> <li>2. Reset the main circuit breaker for the oven. If error reappears contact service provider.</li> </ol>
E-78	2 - Convection fan	VFD (upper) under voltage	<ol style="list-style-type: none"> <li>1. Check to make sure the unit plug is fully seated in the electrical outlet.</li> <li>2. Reset the main circuit breaker for the oven. If error reappears contact service provider.</li> </ol>
E-78	2 - Convection fan	Lower VFD under voltage	<ol style="list-style-type: none"> <li>1. Check to make sure the unit plug is fully seated in the electrical outlet.</li> <li>2. Reset the main circuit breaker for the oven. If error reappears contact service provider.</li> </ol>
E-79	19 - Voltage sensor	Voltage monitor too high	<ol style="list-style-type: none"> <li>1. Check to make sure the unit plug is fully seated in the electrical outlet.</li> <li>2. Reset the main circuit breaker for the oven. If error reappears contact service provider.</li> </ol>
E-79	2 - Convection fan	VFD (upper) over voltage	<ol style="list-style-type: none"> <li>1. Check to make sure the unit plug is fully seated in the electrical outlet.</li> <li>2. Reset the main circuit breaker for the oven. If error reappears contact service provider.</li> </ol>
E-79	2 - Convection fan	Lower VFD over voltage	<ol style="list-style-type: none"> <li>1. Check to make sure the unit plug is fully seated in the electrical outlet.</li> <li>2. Reset the main circuit breaker for the oven. If error reappears contact service provider.</li> </ol>
E-80	2 - Convection fan	VFD (upper) memory error	<ol style="list-style-type: none"> <li>1. Power down control using on/off icon.</li> <li>2. Cycle power to the oven either by unplugging the unit or by turning the main power switch off and then back on.</li> <li>3. Resume use of oven. If error reappears contact a service provider.</li> </ol>
E-80	2 - Convection fan	Lower VFD memory error	<ol style="list-style-type: none"> <li>1. Power down control using on/off icon.</li> <li>2. Cycle power to the oven either by unplugging the unit or by turning the main power switch off and then back on.</li> <li>3. Resume use of oven. If error reappears contact a service provider.</li> </ol>

Code	Component	Description	Troubleshooting steps
E-88	1 - Heater	Gas ignition failure (upper)	<ol style="list-style-type: none"> <li>1. Power down control using on/off icon.</li> <li>2. Cycle power to the oven either by unplugging the unit or turning off the breaker.</li> <li>3. Inspect the top of oven for anything blocking the exhaust flue of the oven.</li> <li>4. Make sure the ventilation hood is turned on and working properly.</li> <li>5. Make sure the gas line is properly connected to the unit and the gas shut off valve is in the open position.</li> <li>6. Resume cook operation. If error reappears turn the oven off, shut off the gas supply to the oven and immediately contact service provider.</li> </ol>
E-88	1 - Heater	Lower gas ignition failure	<ol style="list-style-type: none"> <li>1. Power down control using on/off icon.</li> <li>2. Cycle power to the oven either by unplugging the unit or turning off the breaker.</li> <li>3. Inspect the top of oven for anything blocking the exhaust flue of the oven.</li> <li>4. Make sure the ventilation hood is turned on and working properly.</li> <li>5. Make sure the gas line is properly connected to the unit and the gas shut off valve is in the open position.</li> <li>6. Resume cook operation. If error reappears turn the oven off, shut off the gas supply to the oven and immediately contact service provider.</li> </ol>
E-90	1 - Heater	Gas blower failure (upper)	<ol style="list-style-type: none"> <li>1. Power down control using on/off icon.</li> <li>2. Cycle power to the oven either by unplugging the unit or by turning the main power switch off and then back on.</li> <li>3. Resume use of oven. If error reappears contact a service provider.</li> </ol>
E-90	1 - Heater	Lower gas blower failure	<ol style="list-style-type: none"> <li>1. Power down control using on/off icon.</li> <li>2. Cycle power to the oven either by unplugging the unit or by turning the main power switch off and then back on.</li> <li>3. Resume use of oven. If error reappears contact a service provider.</li> </ol>
E-93	8 - Control Board	State synchronization error between the interface board and control board	<ol style="list-style-type: none"> <li>1. Clear error by pressing the check mark on the display to accept the error.</li> <li>2. If the error persists contact Alto-Shaam Technical Support.</li> </ol>
E-94	10 - Control Board Communications	Communication error between Interface Board and Control Board	<ol style="list-style-type: none"> <li>1. Power down control using on/off icon.</li> <li>2. Cycle power to the oven either by unplugging the unit or by turning the main power switch off and then back on.</li> <li>3. Resume use of oven. If error reappears contact a service provider.</li> </ol>

Code	Component	Description	Troubleshooting steps
<b>E-94</b>	2 - Convection fan	VFD (upper) communication error	<ol style="list-style-type: none"> <li>1. Power down control using on/off icon.</li> <li>2. Cycle power to the oven either by unplugging the unit or by turning the main power switch off and then back on.</li> <li>3. Resume use of oven. If error reappears contact a service provider.</li> </ol>
<b>E-94</b>	2 - Convection fan	Lower VFD communication error	<ol style="list-style-type: none"> <li>1. Power down control using on/off icon.</li> <li>2. Cycle power to the oven either by unplugging the unit or by turning the main power switch off and then back on.</li> <li>3. Resume use of oven. If error reappears contact a service provider.</li> </ol>
<b>E-102</b>	59 - Ventless hood	Ventless hood filter Fault	<ol style="list-style-type: none"> <li>1. Check if filters are installed.</li> <li>2. Check if filters are clogged.</li> <li>3. Check operation of hood fan.</li> </ol>
<b>E-105</b>	6 - Chamber	Low water pressure	<ol style="list-style-type: none"> <li>1. Water supply not connected.</li> <li>2. Water supply is shut off.</li> <li>3. Water supply to unit blocked or obstructed (check filter).</li> </ol>
<b>E-109</b>	6 - Chamber	Chamber high limit	<ol style="list-style-type: none"> <li>1. If the oven has experienced an over temperature condition, allow the oven to cool down for a minimum of 30 minutes.</li> <li>2. Press the high limit reset button.</li> <li>3. Resume cooking operation. If error reappears contact service provider.</li> </ol>
<b>E-606</b>	6 - Chamber	Error during cleaning cycle	<ol style="list-style-type: none"> <li>1. Manually Clean Oven.</li> <li>2. Manually Rinse Oven.</li> <li>3. Ensure chemicals removed before use.</li> <li>4. Resume use of oven. If error repeats contact service provider.</li> </ol>
<b>E-999</b>	48 - Personality handler	IB and CB dip switch settings not set correctly	<ol style="list-style-type: none"> <li>1. Power down control using on/off icon.</li> <li>2. Cycle power to the oven either by unplugging the unit or by turning the main power switch off and then back on.</li> <li>3. Resume use of oven. If error reappears contact a service provider.</li> </ol>

# Warranty

## Introduction

Alto-Shaam, Inc. warrants to the original purchaser only, that any original part found to be defective in material or workmanship will be replaced with a new or rebuilt part at Alto-Shaam's option, subject to provisions hereinafter stated.

## Warranty Period

The original parts warranty period is as follows:

- For all other original parts, one (1) year from the date of installation of appliance or fifteen (15) months from the shipping date, whichever occurs first.
- The labor warranty period is one (1) year from the date of installation or fifteen (15) months from the shipping date, whichever occurs first.
- Alto-Shaam will bear normal labor charges performed during standard business hours, excluding overtime, holiday rates or any additional fees.
- For the refrigeration compressor, if installed, the warranty period is five (5) years from the date of original installation of the appliance.
- For heating elements on Halo Heat® Cook and Hold ovens, the warranty period is for as long as the original owner owns the oven. This warranty period applies to units sold after 2/1/2009 and excludes holding-only ovens.
- To be valid, a warranty claim must be asserted during the applicable warranty period. This warranty is not transferable.

## Exclusions

This warranty does not apply to:

- Calibration.
- Replacement of light bulbs, rubber gaskets, grease filters, air filters, racks, jet plates, and/or the replacement of glass due to damage of any kind.
- Equipment damage caused by accident, shipping, improper installation or alteration.
- Equipment used under conditions of abuse, misuse, carelessness or abnormal conditions, including but not limited to, equipment subjected to harsh or inappropriate chemicals, including but not limited to, compounds containing chloride or quaternary salts, poor water quality, or equipment with missing or altered serial numbers.
- Equipment damage caused by use of any cleaning agents other than those recommended by Alto-Shaam, including but not limited to damage due to chlorine or other harmful chemicals.
- Any losses or damage resulting from malfunction, including loss of food product, revenue, or consequential or incidental damages of any kind.
- Equipment modified in any manner from original model, substitution of parts other than factory authorized parts, unauthorized removal of any parts including legs, or unauthorized addition of any parts.

*Continued on next page*

*Continued from previous page*

- Equipment damage incurred as a direct result of poor water quality\*, inadequate maintenance of steam generators and/or surfaces affected by water. Water quality and required maintenance of steam generating equipment is the responsibility of the owner/operator.
  - Equipment damage incurred as a result of not following the required maintenance schedule published in the manuals for the equipment.
- 

## **Conclusion**

This warranty is exclusive and is in lieu of all other warranties, express or implied, including the implied warranties of merchantability and fitness for a particular purpose. No person except an officer of Alto-Shaam, Inc. is authorized to modify this warranty or to incur on behalf of Alto-Shaam any other obligation or liability in connection with Alto-Shaam equipment.

*\*Refer to the product spec sheet for water quality standards.*

# DECLARATION OF CONFORMITY

**Manufacturer:**

Alto-Shaam, Inc.  
 W164 N9221 Water Street  
 Menomonee Falls, WI 53202-0450  
 U.S.A.



**EQUIPMENT TYPE:** Household and Similar Electric Appliances

**EQUIPMENT DESCRIPTION:** Commercial Steam Convection Ovens

**MODEL NUMBER:** CTP6-10E, CTP10-10E, CTP7-20E  
 CTP10-20E, CTP20-10E, CTP20-20E  
 CTC6-10E, CTC10-10E, CTC7-20E  
 CTC10-20E, CTC20-10E, CTC20-20E

**APPLIED DIRECTIVES** LVD (Low Voltage Directive) 2014/35/EC  
 MD (Machinery Directive) 2006/42/EC  
 EMC – 2014/30/EC

**APPLIED STANDARDS:** EN 60335-1:2012,  
 EN 60335-2-42: 2003 + A1:2008 + A11:2012  
 EN 55014-1, EN 55014-2  
 EN61000-3-2, EN61000-3-3



*We the undersigned, hereby declare that the equipment specified above conforms to the above Directives and Standards*

Manufacturer Name:  
**ALTO-SHAAM INC.**  
**NAME:** Mrs. Christa Pieper  
**TITLE:** Certification Manager  
**SIGNATURE:** *Christa Pieper*  
**DATE:** *April - 20 - 2016*



DECLARATION OF CONFORMITY

# DECLARATION OF CONFORMITY

**Manufacturer:**

Alto-Shaam, Inc.  
W164 N9221 Water Street  
Menomonee Falls, WI 53202-0450  
U.S.A.



**EQUIPMENT TYPE:** Household and Similar Electric Appliances

**EQUIPMENT DESCRIPTION:** Commercial Steam Convection Ovens

**MODEL NUMBER:** CTP6-10G, CTP10-10G, CTP7-20G  
CTP10-20G, CTP20-10G, CTP20-20G  
CTC6-10G, CTC10-10G, CTC7-20G  
CTC10-20G, CTC20-10G, CTC20-20G

**APPLIED DIRECTIVES** LVD (Low Voltage Directive) 2014/35/EC  
MD (Machinery Directive) 2006/42/EC  
EMC – 2014/30/EC

**APPLIED STANDARDS:** EN 60335-1:2012,  
EN 60335-2-42: 2003 + A1:2008 + A11:2012  
EN 55014-1, EN 55014-2  
EN61000-3-2, EN61000-3-3



*We the undersigned, hereby declare that the equipment specified above conforms to the above Directives and Standards*

Manufacturer Name:  
**ALTO-SHAAM INC.**  
NAME: Mrs. Christa Pieper  
TITLE: Certification Manager  
SIGNATURE: *Christa Pieper*  
DATE: *April - 20 - 2016*



# DECLARATION OF CONFORMITY

**Manufacturer:**  
Alto-Shaam, Inc.  
W164 N9221 Water Street  
Menomonee Falls, WI 53202-0450



**EQUIPMENT TYPE:** Household and Similar Electric Appliances

**EQUIPMENT DESCRIPTION:** Commercial Steam Convection Ovens

**MODEL NUMBER:** CTP6-10E, CTP10-10E, CTP7-20E, CTP10-20E, CTP20-10E, CTP20-20E, CTC6-10E, CTC10-10E, CTC7-20E, CTC10-20E, CTC20-10E, CTC20-20E

**APPLIED UK REGULATIONS:**

- Supply of Machinery (Safety) Regulations 2008
- Electromagnetic Compatibility Regulations 2016
- The Restriction of the Use of Certain Hazardous Substances in Electrical and Electronic Equipment Regulations 2012
- The Ecodesign for Energy-Related Products and Energy Information (Amendment) (EU Exit) Regulations 2019

**APPLIED STANDARDS:**

EN 60335-1:2012  
EN 60335-2-42:2003 + A1:2008 + A11:2012  
EN 55014-1:2018, EN 55014-2:2016



*We the undersigned, hereby declare that the equipment specified above conforms to the above Directives and Standards*

Manufacturer Name:  
**ALTO-SHAAM INC.**  
**NAME:** Christa Pieper  
**TITLE:** Certification Manager

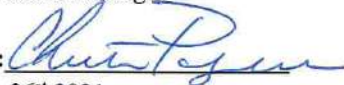
**SIGNATURE:**   
**DATE:** July, 26<sup>th</sup> 2021







**ALTO-SHAAM**

Menomonee Falls, WI U.S.A.

Phone 800-558-8744 | +1-262-251-3800 | [alto-shaam.com](http://alto-shaam.com)