



Quality Refrigeration

OWNER'S MANUAL



G-Series Reach-In & Pass Thru Refrigerator, Freezer & Hot Holding

**For equipment produced after 09-15-2017 only.*

4401 Blue Mound Road Fort Worth, Texas 76106 (USA)

Phone: 800.825.8220 | Service Fax: 817.740.6757 | E-mail: service@traulsen.com | Website: traulsen.com

Hours Of Operation: Monday - Friday 7:30 a.m. - 4:30 p.m. (CST)

TABLE OF CONTENTS

1. THE SERIAL TAG	Page 1	6. OTHER	
2. RECEIPT INSPECTION	Page 2	A-Service Information	Page 6
3. INSTALLATION		B-Spare Parts	Page 6
A-Location	Page 2	C-Warranty Registration	Page 6
B-Packaging	Page 2	7. MICROPROCESSOR CONTROL	
C-Installing Legs or Casters	Page 2	A-Control Features	Page 6
D-Shelf Pins	Page 3	B-Control Panel	Page 7
E-Removing The Doors & Hardware	Page 3	C-Parts Assembly	Page 7
F-Cord & Plug	Page 3	D-Notes To The User	Page 8
G-Power Supply	Page 3	E-Enter The Customer Password	Page 8
H-Wiring Diagram	Page 3	F-Enter The Technician Password	Page 9
I-Clearance	Page 4	G-Service Parameters	Page 10
J-Installing Optional Interior Kits	Page 4	H-Adjust The Set Point	Page 11
K-ON/OFF Switch	Page 4	I-Adjust The Set Point Differential	Page 11
4. OPERATION		J-Change The Temperature Scale	Page 11
A-Refrigerators	Page 4	K-Set Date & Time	Page 12
B-Freezers	Page 4	L-Set Daylight Savings	Page 12
C-Light Switches	Page 5	M-Start A Defrost	Page 13
D-Turn Off Temperature Display-Main Display		N-Set Defrost Mode	Page 13
Short Cut	Page 5	O-Set Defrost Schedule	Page 13
5. CARE & MAINTENANCE		P-View The Sensor Temperatures	Page 14
A-Cleaning The Condenser	Page 5	Q-Hot Food-Unlocking The Keypad	Page 15
B-Hinge Replacement	Page 5	R-Hot Food-Adjust The Set Point	Page 15
C-Replacing The Gaskets	Page 5	S-Hot Food-Change The Temperature Set Point	
D-Cleaning The Exterior	Page 6	(Short Cut)	Page 15
E-Cleaning The Interior	Page 6	T-Hot Food-Turn The Unit Off	Page 15
F-Adjusting The Shelves	Page 6	8. SPARE & REPLACEMENT PARTS LISTING	Page 16
		9. TROUBLESHOOTING GUIDE	Page 17
		10. WARRANTY INFORMATION	Page 18



FORT WORTH, TX. USA

SERIAL VOLTS	MODEL Hz	PH	
TOTAL CURRENT	AMPS		
MINIMUM CIRCUIT	AMPS		
MAXIMUM OVERCURRENT PROTECTION			AMPS
LIGHTS	WATTS		
HEATERS	AMPS		
REFRIGERANT DESIGN PRESSURE		TYPE HIGH	OZ LOW
REFRIGERANT DESIGN PRESSURE		TYPE HIGH	OZ LOW

370-60294-00 REV (A)



1. THE SERIAL TAG

The serial tag is a permanently affixed label upon which is recorded vital electrical and refrigeration data about your Traulsen product, as well as the model and serial number. This tag is located in the upper right interior compartment on all Traulsen G-Series refrigerator and freezer models.

READING THE SERIAL TAG

- Serial = The permanent ID# of your Traulsen
- Model = The model # of your Traulsen
- Volts = Voltage
- Hz = Cycle
- PH = Phase
- Total Current = Maximum amp draw
- Minimum Circuit = Minimum circuit ampacity
- Lights = Light wattage
- Heaters = Heater amperage (Hot Food units only)
- Refrigerant = Refrigerant type used
- Design Pressure = High & low side operating pressures and refrigerant charge
- Agency Labels = Designates agency listings

2. RECEIPT INSPECTION

All Traulsen products are factory tested for performance and are free from defects when shipped. The utmost care has been taken in crating this product to protect against damage in transit. All interior fittings have been carefully secured and the casters/legs are boxed and strapped inside to prevent damage. Door keys will be attached to the handle with a nylon strip. The handle is protected by an easily removable nylon netting.

You should carefully inspect your Traulsen unit for damage during delivery. If damage is detected, you should save all the crating materials and make note on the carrier's Bill Of Lading describing this. A freight claim should be filed within 5 days. If damage is subsequently noted during or immediately after installation, contact the respective carrier and file a freight claim. Under no condition may a damaged unit be returned to Traulsen without first obtaining written permission (return authorization). You may contact Traulsen customer care at (800) 333-7447 to request a return.

3. INSTALLATION

3A - LOCATION:

Select a proper location for your Traulsen unit, away from extreme heat and allow proper clearance for air circulation (see page 4). Allow enough clearance between the unit and the side wall in order to make use of the door stay open feature at 120° (self-closing feature operates up to 90°). The door(s) must be able to open a minimum of 90° in order to make use of the maximum clear door width available.

3B - PACKAGING:

All Traulsen units are shipped from the factory bolted to a sturdy wooden pallet and packaged in a durable Styrofoam backed cardboard wrap.

Most exterior stainless steel and aluminum surfaces have a protective vinyl covering to prevent scratching during manufacturing, shipping and installation. After the unit is installed in place of service, remove and discard the covering from all surfaces.

If at all possible we suggest that the cabinet remain bolted to the pallet during all transportation to the point of final installation. To remove the wooden pallet, the bolts can then be removed with a 3/4" socket wrench. Avoid laying the unit on its front, side or back for removal of the pallet.

NOTE: DO NOT LAY THE UNIT ON ITS SIDE DURING TRANSPORTATION OR INSTALLATION.

3. INSTALLATION (cont'd)

3C - INSTALLING CASTERS OR LEGS:

A set of four (4) 6" high casters and sixteen (16) bolts are supplied standard for all Traulsen G-Series units. These are shipped from the factory packed inside a cardboard box which is strapped inside the cabinet to the lower shelf.

Legs in lieu of casters are available as an optional accessory kit for the same models. These are shipped inside a separate cardboard box. Inside it should contain four (4) legs and sixteen (16) bolts.

WARNING: THE CABINET MUST BE BLOCKED AND STABLE BEFORE INSTALLING LEGS OR CASTERS.

To install the legs or casters, first raise and block the reach-in a minimum of 7" from the floor. For installing legs, thread the legs into the threaded holes on the bottom of the cabinet (see figure 1). Be certain that all legs are tightly secured. When the unit is set in its final position, it is important for proper operation that the unit be level. The legs are adjustable for this purpose, turn the bottom of the leg counterclockwise to raise it, clockwise to lower it. Level the unit from front to back as well as side to side in this manner.

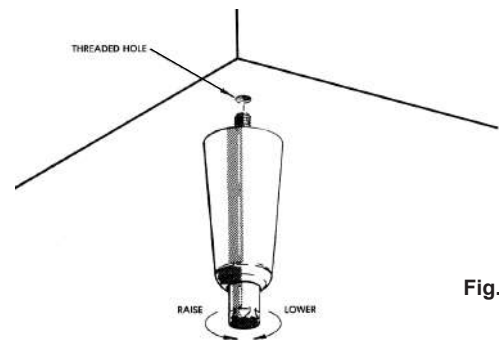

Fig. 1

Please note that Traulsen units are not designed to be moved while on legs. If the unit requires moving, a pallet jack or forklift should be used to prevent damage. For installing casters, the casters are a "plate" type, and require the use of four (4) bolts each to secure them firmly to the cabinet bottom at each corner (see figure 2). The caster bolts are tightened using a 1/2" socket wrench.

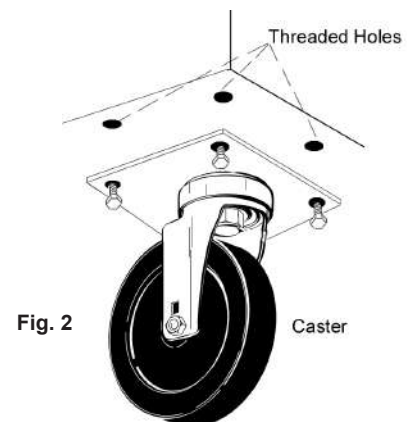

Fig. 2

3. INSTALLATION (cont'd)

3D - SHELF PINS:

The unit is supplied with shelves and shelf pins installed. Check all shelf pins to assure they are tightened down as they may have come loose during shipping. Rotate the pins clockwise until they are secured against the side of the cabinet.

3E - REMOVING THE DOORS & HARDWARE:

In order to fit through narrow (less than 35") doorways, it may be necessary to remove the door(s), and/or hinges. To remove any solid door, begin by removing the plug at the bottom of the top hinge. Inside the hinge there is a small screw which secures the door in place. Remove this with a flat head screwdriver and the door can then be lifted off the hinges (see figure 3).

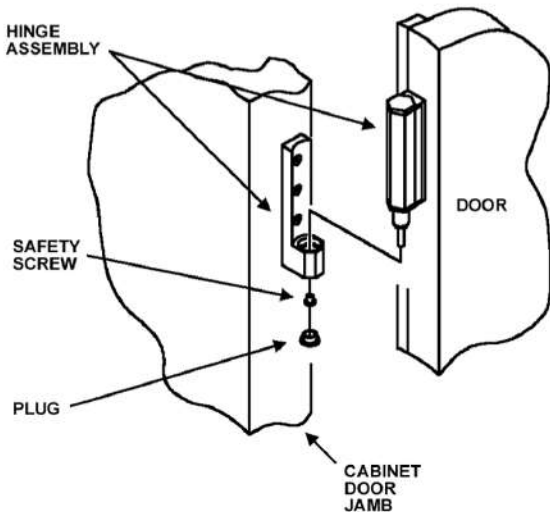

Fig. 3

After removing the door, it may be necessary to remove the hinge assembly and hardware from the door itself.

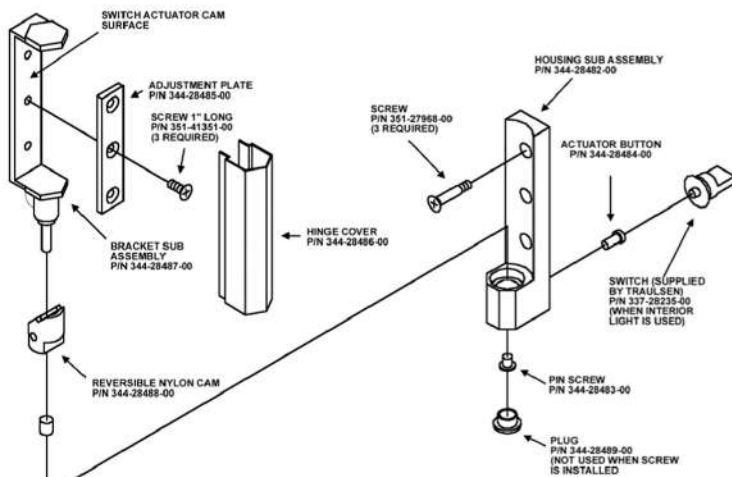

Fig. 4

3E - REMOVING THE DOORS & HARDWARE (cont'd):

If it is necessary to remove the hinge hardware from the cabinet, begin by removing the three Phillips head screws which hold it in place. Set these components aside for later reassembly. Pay special attention not to lose the door switch actuator button controls evaporator fan and interior light operation (see figure 4).

NOTE: All solid door units include a microswitch for controlling the interior lighting in the top hinge(s). Special care should be taken to not damage the wiring for this during the hinge removal process.

The lock keeper may also require removal in order to reduce the overall cabinet depth to 32".

Next remove the lock keeper bracket by removing the two (2) flat head screws which secure it in place. Set these components aside for later reassembly.

To re-install the door and/or hinges, please reverse the appropriate sections of the preceding procedure.

3F - CORD & PLUG:

All G-Series models are supplied with a cord & plug attached. It is shipped coiled at the top of the cabinet, secured by a nylon strip. For your safety and protection, all units supplied with a cord and plug include a special three-prong grounding plug on the service cord. Select only a dedicated electrical outlet with grounding plug for power source.

NOTE: Do not under any circumstances, cut or remove the round grounding prong from the plug, or use an extension cord.

3G - POWER SUPPLY:

The supply voltage should be checked prior to connection to be certain that proper voltage for the cabinet wiring is available (refer to the serial tag to determine correct unit voltage). Make connections in accordance with local electrical codes. Use qualified electricians.

Use of a separate, dedicated circuit is required. Size wiring to handle indicated load and provide necessary over current protector in circuit (see amperage requirements on the unit's serial tag).

3H - WIRING DIAGRAM:

Refer to the wiring diagram located on the exterior back of the cabinet for any service work performed on the unit. Should you require one, please contact Traulsen Service at (800) 825-8220, and provide the model and serial number of the unit involved.

3. INSTALLATION (cont'd)

3I - CLEARANCE:

In order to assure optimum performance, the condensing unit of your Traulsen unit **MUST** have an adequate supply of air for cooling purposes. Therefore, the operating location must either have a minimum of 12" clearance overhead of the condensing unit or allow for unrestricted air flow at the back of the unit. Clearance of at least 12" above is required in order to perform certain maintenance tasks.

3J - INSTALLING OPTIONAL INTERIOR KITS:

In addition to their standard interiors, G-Series models also offer the option for additional shelves or tray slides. If ordered, these are shipped as kits along with the unit, packaged in a separate cardboard box which contains all the necessary parts and hardware for on-site installation.

To install additional shelves, first remove the white plastic covers from inside the cabinet. These are located along the same vertical line as the pins already in place on the interior side walls, back and center mullion (two and three-section models). This exposes threaded holes in which you may position the new shelves. Next insert the gray plastic shelf pins into these holes and tighten by turning clockwise with your fingers. After all four pins are in place, the new shelf should be placed to rest on top of them. The unused plastic covers may be discarded or saved for future changes to the cabinet interior.

Installation of optional tray slides varies with each cabinet, and with each type of tray slide ordered. To install optional tray slides, follow the directions packaged inside the kit carton.

3K - ON/OFF SWITCH:

An **ON/OFF** toggle switch for the power supply is provided. It is located on top of the unit, mounted to the side of the evaporator housing. This is shipped from the factory in the **ON** position.

4. OPERATION

4A - REFRIGERATORS:

Both refrigerators and freezers do not require manual defrosting. During normal operation, a refrigerator continuously circulates above freezing cabinet air through the evaporator coil. An electric defrost occurs every 8 hours for a maximum length of 25 minutes to melt any frost which may accumulate on the coil during the compressor "ON" cycle. With standard holding refrigerators, high relative humidity is also maintained to prevent dehydration of stored product.

4. OPERATION (cont'd)

4B - FREEZERS:

During normal operation, a freezer continuously circulates below freezing cabinet air through the evaporator coil. The coil requires a periodic defrosting for proper operation. This is accomplished by an automatic, time activated, temperature/time terminated, defrost program. The controller is preset at the factory for six equally spaced defrost cycles within each 24-hour period.

The evaporator fan(s) cycle off with each door opening. The evaporator fan(s) will cycle on (15 seconds) and off (45 seconds) during the compressor off cycle. During the compressor on cycle the evaporator fan(s) will run continuously.

At the start of a refrigerator or freezer defrost cycle, both the compressor and evaporator fans are off. The microprocessor control will read "dEF" (see figure 5).



Fig. 5

The electric heater (attached to the coil) is energized. When the temperature sensor affixed to the coil senses 45°F, the coil is fully defrosted and the compressor operation is resumed, defrost heaters are automatically turned off. The evaporator coil fans are delayed from starting at the termination of a defrost cycle. Fan operation is automatically resumed, after a short time or temp delay (whichever comes first). After completion, the total refrigeration system operation is then resumed. During defrost operation, heat is confined to the coil enclosure to prevent any significant rise in temperature within the food zone. The fan delay control function upon termination of a defrost cycle is two-fold. First, to prevent blowing warm air into the food storage area. Second, to prevent any condensation on the defrost coil from being blown into the food storage area.

The microprocessor control is set from the factory to terminate defrost at 25 minutes for refrigerators and 30 minutes for freezers in the event of a sensor failure. This setting should never be tampered with, without first consulting the factory.

4. OPERATION (cont'd)



4C - LIGHT SWITCHES:

All G-Series models include a concealed door switch mounted in the top door hinge(s), which automatically activates the interior light when the door is opened. When the door is closed, the lights are not operating.

In addition, on hinged glass door models, an exterior mounted, illuminated red switch is included for manual light control. In the **ON** position, the lights are illuminated whether the doors are open or not. In the **OFF** position, the lights are controlled by the hinge switch as described in the first paragraph.

4D - TURN OFF TEMPERATURE DISPLAY-MAIN DISPLAY

SHORT CUT: There is a short cut to disable the external temperature display. Note that before doing so you must install an interior mounted thermometer in order to conform with local health codes.

DISPLAY SYMBOL	DISPLAY DESCRIPTION
	Unlock Key
	Keypad Unlock LED

- Press the **Unlock Key** twice within a second in order to unlock the keypad (think “tap-tap”).
- The **Keypad Unlock LED** will turn on to indicate the keypad is now live.

- Press and hold the **Unlock Key** for 3 seconds until the temperature display goes blank.

To restore the temperature display, press any key except the **Unlock Key**:

- Press the **Unlock Key** twice within a second in order to unlock the keypad (think “tap-tap”).
- The **Keypad Unlock LED** will turn on to indicate the keypad is now live.
- Press any key except the Unlock Key to restore the temperature display.

5. CARE & MAINTENANCE

WARNING: DISCONNECT ELECTRICAL POWER SUPPLY BEFORE CLEANING ANY PARTS OF THE UNIT.

5A - CLEANING THE CONDENSER:

The most important thing you can do to insure a long, reliable service life for your Traulsen is to regularly clean the condenser coil.

The condensing unit requires regularly scheduled cleaning to keep the finned condenser clean of lint and dust accumulation. Keeping the condenser clean allows the cabinet to operate more efficiently and use less energy. To clean the condenser, first disconnect electrical power to the cabinet and lift up the front louver assembly. To lift this, remove the two screws located on both sides at the bottom of the louver assembly (see figure 5). Once the screws are removed, the panel can be pivoted upwards allowing full access to the front facing condenser (see figure 6).

5. CARE & MAINTENANCE (cont'd)

5A - CLEANING THE CONDENSER (cont'd):

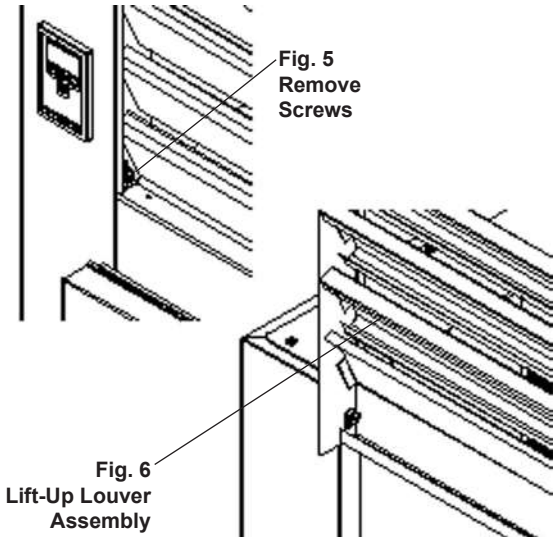

Vacuum or brush any dirt, lint or dust from the finned condenser coil, the compressor and other cooling system parts. If significant dirt is clogging the condenser fins, use compressed air to blow this clear. Care should be taken not to bend any of the condenser fins, as this will reduce performance and compressor life. Lower louver assembly and replace screws to hold it in place.

5B - HINGE REPLACEMENT:

To remove the door, remove the plug at the bottom of the top hinge. Behind this is a screw which secures the door in place. Remove this with a flat head screwdriver and then lift the door off the hinge. To remove the door portion of the hinge, lift off the hinge cover and then remove the 3 Phillips head screws which secure the hinge in place. To remove the cabinet portion of the hinge, remove the 3 Phillips head screws which hold it in place. On solid door units, the top hinge(s) contains a switch for controlling the lights. To reassemble the hinge reverse the procedure.

5C - REPLACING THE GASKETS:

To remove the gasket to be replaced, grasp it firmly by one corner and pull it out. Before attempting to install a new gasket, both the unit and gasket must be at room temperature. Insert the four corners first by using a rubber mallet (or hammer with a block of wood). After the corners are properly inserted, work your way towards the center from both ends by gently hitting with a mallet until the gasket is completely seated in place (see figure 7 for proper gasket placement).

NOTE: The gasket may appear too large, but if it is installed as indicated above it will slip into place.

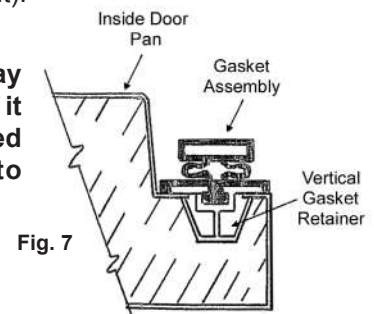

5. CARE & MAINTENANCE (cont'd)

5D - CLEANING THE EXTERIOR:

Exterior stainless steel and aluminum should be cleaned with warm water, mild soap and a soft cloth. Apply with a dampened cloth and wipe in the direction of the metal grain.

Avoid the use of strong detergents and gritty, abrasive cleaners as they may tend to mar and scratch the surface. **Do NOT** use cleansers containing chlorine, this may promote corrosion of the stainless steel.

Care should also be taken to avoid splashing the unit with water, containing chlorinated cleansers, when mopping the floor around the unit.

For stubborn odor spills, use baking soda and water (mixed to a 1 TBSP baking soda to 1 pint water ratio).

5E - CLEANING THE INTERIOR:

For cleaning anodized aluminum interiors, the use of baking soda as described in section "V. d" is recommended. Use on breaker strips as well as door gaskets. All interior fittings are removable without tools to facilitate cleaning.

5F - ADJUSTING THE SHELVES:

For shelves mounted on pins, first select the desired location and remove the white plastic covers in the interior back and sides by rotating them counterclockwise. Remove the shelf pins by rotating them counterclockwise. Install the pins in the desired location by rotating clockwise. Make sure the pin is securely tightened down. Do not over tighten. Slide the shelf into its new position, and replace the white plastic covers into the holes vacated by the shelf pins.

6. OTHER

6A - SERVICE INFORMATION:

Before calling for service, please check the following:

- Is the electrical cord plugged in?
- Is the fuse OK or circuit breaker on?
- Is the power switch "ON"?

If after checking the above items and the unit is still not operating properly, please contact an authorized Traulsen service agent. You may obtain the name of a service agent from the Service tab of our website: www.traulsen.com.

6. OTHER (cont'd)

6A - SERVICE INFORMATION (cont'd):

If service is not satisfactory, please contact our in-house service department at: **Traulsen**
4401 Blue Mound Road Fort Worth, TX 76106
(800) 825-8220

Traulsen reserves the right to change specifications or discontinue models without notice.

6B - SPARE PARTS:

Spare or replacement parts may be obtained through a parts supplier or one of our authorized service agents (see page 17-18 for parts listing). A list of authorized service agents is posted on our company's official website Service tab at www.traulsen.com.

6C - WARRANTY REGISTRATION:

The warranty for your new Traulsen unit may be registered with us by completing warranty information online, via our website www.traulsen.com click on Service Tab or calling us direct at 800-825-8220.

7. MICROPROCESSOR CONTROL



Your new Traulsen G-Series Refrigerator, Freezer or Hot Food is equipped with an electronic microprocessor control, which precisely regulates operation. It is supplied from the factory completely ready for use. See pages 6 thru 14 for more information.

7A - CONTROL FEATURES:

Internal Time Clock

- Eliminates defrost time clock (refrigerator and freezer models only).
- See "Setting The 24-Hour Clock" on Page 11. (Also required at "Start Up")

Parameter/Service Levels

- See "Customer/Service Parameters" on Page 8 - 9.

Defrost - See "Setting Defrost" on page 12

- Customers can set up to 6 different defrost schedules. The defrost schedule allows the customer to decide when defrosts will take, preventing a defrost cycle during peak kitchen use. **NOTE: The 24-hour clock must be set for this feature to operate correctly.**

7. MICROPROCESSOR CONTROL (cont'd)

7B - CONTROL PANEL:

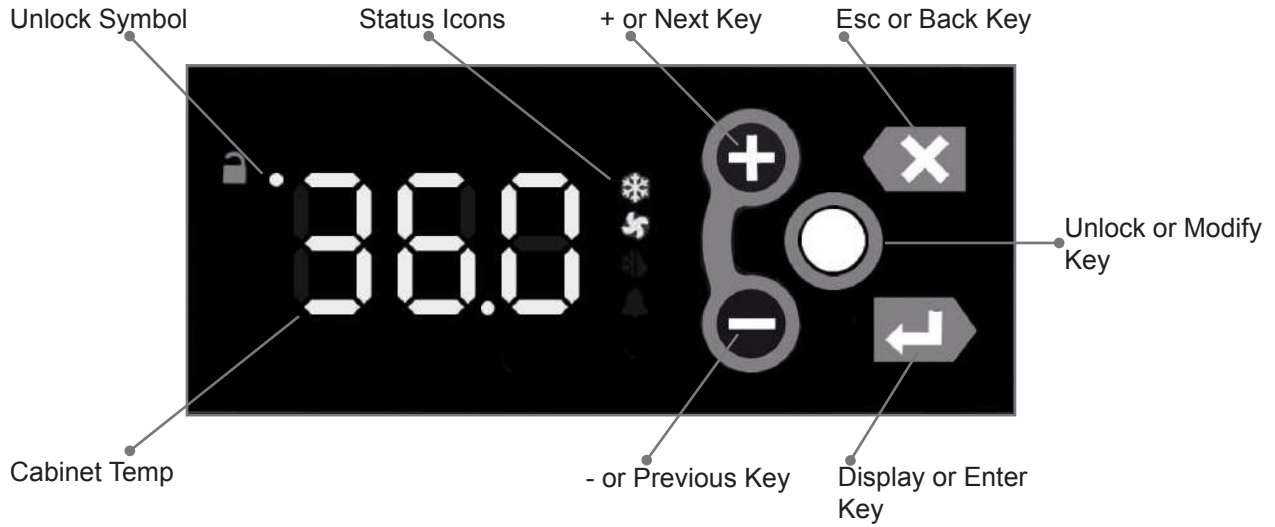

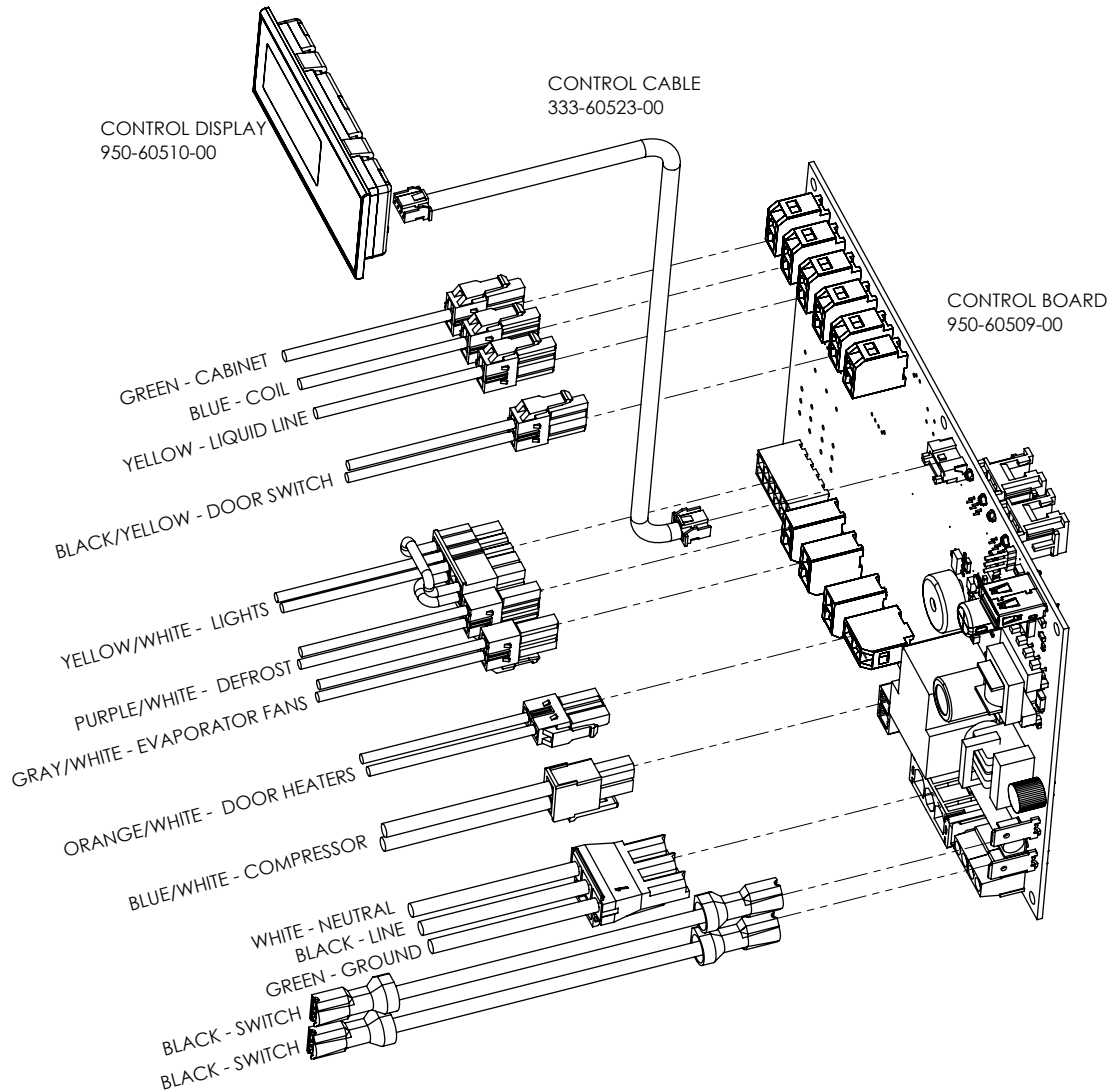

7C - PARTS ASSEMBLY:

NOTE: Parts can be ordered separately by calling Traulsen at 800-825-8220. Requires unit model and serial to place order. Please contact factory direct for hot food control drawing if required.



7. MICROPROCESSOR CONTROL (cont'd)









7D - NOTES TO THE USER:

DISPLAY SYMBOL	DISPLAY DESCRIPTION
	ESC Key
	Unlock Key

You only have 3 minutes between button pushes. If you take longer than 3 minutes, the keypad will lock. The Menu System has a 10 minute timeout. After 10 minutes of inactivity, the controller will revert back to displaying the cabinet temperature. You can exit the Menu System at any time by pressing the **Esc Key** until the cabinet temperature is displayed. If you are making changes and the keypad locks, press the **Unlock Key** twice within a second in order to unlock the keypad (think “tap-tap”).

7E - ENTER THE CUSTOMER PASSWORD:

In order to access the menu system, the user must enter a password first. Once the password is entered, it remains in effect until the user returns to the Main Display (the cabinet temperature). If the user does not exit the menu system, the controller will time-out after 10 minutes of inactivity. The keypad must be unlocked to access the menu system.

DISPLAY SYMBOL	DISPLAY DESCRIPTION
	Unlock Key
	Keypad Unlock LED
	Enter Key
	SEn
	Plus (+) /Next Key
	SEt/Settings
	AL
	SdF
	Minus (-) /Previous Key









- Press the **Unlock Key** twice within a second in order to unlock the keypad (think “tap-tap”)
- The **Keypad Unlock LED** will turn on to indicate the keypad is now live
- To enter the Menu System, press the **Enter Key**
- The display will show “SEn”
- Press the **Plus Key** to scroll through the menu system. The choices are:
 - o “SEn” for the Sensors submenu
 - o “SEt” for the Settings submenu
 - o “AL” for the Alarm submenu
 - o “SdF” to start a defrost

- **Enter Key** to select the desired submenu
- The display will show “000”. The first “0” will flash.
- Use the **Plus Key** or the **Minus Key** to modify the flashing digit until it reads “1”.
- Press the **Enter Key** to accept the value
- Repeat for the 2nd and 3rd digits until the displays shows “111”.
- Press the **Enter Key** to enter the desired submenu.



7. MICROPROCESSOR CONTROL (cont'd)

7F - ENTER THE TECHNICIAN PASSWORD:

In order to access the menu system, the user must enter a password first. Once the password is entered, it remains in effect until the user returns to the Main Display (the cabinet temperature). If the user does not exit the menu system, the controller will time-out after 10 minutes of inactivity. The keypad must be unlocked to access the menu system.

DISPLAY SYMBOL	DISPLAY DESCRIPTION
	Unlock Key
	Keypad Unlock LED
	Enter Key
	SEn
	Plus (+) /Next Key
	SEt
	AL
	SdF

- Press the **Unlock Key** twice within a second in order to unlock the keypad (think “tap-tap”).
- The **Keypad Unlock LED** will turn on to indicate the keypad is now live.
- To enter the Menu System, press the **Enter Key**.
- The display will show “SEn”.
- Press the **Plus Key** to scroll through the menu system. The choices are:
 - o “SEn” for the Sensors submenu
 - o “SEt” for the Settings submenu
 - o “AL” for the Alarm submenu
 - o “SdF” to start a defrost

DISPLAY SYMBOL	DISPLAY DESCRIPTION
	Enter Key
	Plus (+) /Next Key
	Minus (-) /Previous Key

- **Enter Key** to select the desired submenu.
- The display will show “000”. The first “0” will flash.
- Use the **Plus Key** or the **Minus Key** to modify the flashing digit until it reads “5”.
- Press the **Enter Key** to accept the value
- Repeat for the 2nd and 3rd digits until the displays shows “555”.
- Press the **Enter Key** to enter the desired submenu.

7. MICROPROCESSOR CONTROL (cont'd)

7G - SERVICE PARAMETERS-MENU SYSTEM:

DISPLAY SYMBOL	DISPLAY DESCRIPTION
	Plus (+) /Next Key
	Keypad Unlock
	SEt/Settings
	Enter Key
	Set Point
	Plus (+) /Next Key
	Set Point Differential
	Modify Key

Listed below are the available parameters in the order they appear, use the **Plus Key** on the controller to sequence through menu system. The **Keypad must be Unlocked** to access the menu system.

- Follow the instructions to enter the technician password (see page 9).
- Use the **Plus Key** to move to the **Settings** submenu.
- Press the **Enter Key** to enter the **Settings** submenu.
- The first parameter displayed will be the **Set Point** parameter is displayed.
- Press the **Enter Key** to display the value of the **Set Point**.
- Use the **Plus Key** to move to the next parameter (**Set Point Differential**).
- Press the **Enter Key** to display the value of the **Set Point Differential**.
- Press the **Modify Key** to change a setting. The value will flash, indicating it is being modified.
- Use the **Plus Key** to move through the settings parameters.

DISPLAY SYMBOL	DISPLAY DESCRIPTION
	Set Point
	Set Point Differential
	Aux Device Set Point
	Aux Device Set Point Differential
	Cabinet Fan Door Action
	Defrost Set Point
	Defrost Mode
	Defrost Interval
	Defrost Time1
	Defrost Time2
	Defrost Time3
	Defrost Time4
	Defrost Time5
	Defrost Time6
	Door Heater Mode
	Door Heater Delay
	Serial Number
	Software Version
	Temp Units
	Time Zone
	Daylight Savings Flag

The following parameters are available:

- o Cabinet Set Point
- o Set Point Differential
- o Aux Device Set Point
- o Aux Device Set Point Differential
- o Cabinet Fan Door Action
- o Defrost Set Point
- o Defrost Mode
- o Defrost Interval
- o Defrost Time1
- o Defrost Time2
- o Defrost Time3
- o Defrost Time4
- o Defrost Time5
- o Defrost Time6
- o Door Heater Mode
- o Door Heater Delay
- o Serial Number
- o Software Version
- o Temp Units
- o Time Zone
- o Daylight Savings Flag

In General:

- Use the **Plus Key** and the **Minus Key** to move through the Menu System.
- Press the **Enter Key** to display the value of the selected parameter.
- Press the **Modify Key** to change a setting. The value will flash, indicating it is being modified.
- Once the value is flashing, use the **Plus Key** and the **Minus Key** to change the setting.
- When the display shows the desired setting, press the **Enter Key** to accept the value.
- Press the **Esc Key** to abort an edit operation.







DISPLAY SYMBOL	DISPLAY DESCRIPTION
	Plus (+) /Next Key
	Minus (-) /Previous Key
	Enter Key
	Modify Key
	Esc Key

7. MICROPROCESSOR CONTROL (cont'd)

7H - ADJUST THE SETPOINT - MENU SYSTEM:

This parameter sets the low point of the desired cabinet temperature range. The set point can be configured from the Main Display using the short cut (see section XX), or from the Menu System.







Typically, freezers will range from -3° F to 0° F (-19° C to -18° C) and refrigerators will range from 35° F to 38° F (2° C to 4° C) for this parameter setting. This parameter is preset at the factory and does not require adjustment unless the customer chooses to do so. The setpoint for the unit can be changed from the Menu System. There will be a minimum and maximum value allowed for the set point. The keypad must be unlocked to access the menu system.

DISPLAY SYMBOL	DISPLAY DESCRIPTION
	SEt/Settings
	Enter Key
	Plus (+) /Next Key
	Set Point
	Value Of Set Point
	Modify Key
	Minus (-) /Previous Key

- Follow the instructions to enter the customer password and **Settings** submenu.
- Press the **Enter Key** to enter the Settings submenu.
- Use the **Plus Key** until the **Setpoint** parameter is displayed
- Press the **Enter Key** to display the **value of the setpoint**.
- Press the **Modify Key** and the value will flash, indicating it is being modified
- To raise the setpoint, press the **Plus Key** to increment to the set point. Press the **Minus Key** to lower the setpoint.
- When the desired value is reached, press the **Enter Key** to lock in the value.

7I - ADJUST THE SETPOINT DIFFERENTIAL - MENU SYSTEM:

This parameter sets the number of degrees the air temp will rise above set point before the refrigeration system will cycle on. The set point differential is set at 2 for both refrigerator and freezer models which will allow the air temperature to rise 2 degrees above SP (set point) setting before cycling refrigeration on. This parameter is preset at the factory and does not require adjustment unless the customer chooses to do so. The setpoint differential can be changed from the Menu System. There will be a minimum and maximum value allowed for the set point differential. The keypad must be unlocked to access the menu system.







DISPLAY SYMBOL	DISPLAY DESCRIPTION
	SEt/Settings
	Plus (+) /Next Key
	Set Point Differential
	Enter Key
	2.0 Set Point Value
	Modify Key
	Minus (-) /Previous Key

- Follow the instructions to enter the technician password and **Settings** submenu.
- Use the **Plus Key** until the **Setpoint Different** parameter is displayed
- Press the **Enter Key** to display the value of the set point **2.0**.
- Press the **Modify Key** and the value will flash, indicating it is being modified
- To raise the set point differential, press the **Plus Key** to increment to the set point differential. Press the **Minus Key** to lower the set point differential.
- When the desired value is reached, press the Enter Key to lock in the value.

7J - CHANGE THE TEMPERATURE SCALE - MENU SYSTEM:

The temperature scale determines if the temperature displayed will be in degrees **Fahrenheit** or degrees **Celsius**. The keypad must be unlocked to access the menu system.

- Follow the instructions to enter the technician password and **Settings** submenu.
- Use the **Minus Key** until the **Temperature Units** parameter is displayed.
- Press the **Enter Key** to display the **value of the temperature units**.
- Press the **Modify Key** and the value will flash, indicating it is being modified.
- To change the temperature units, press the **Plus Key** to step through the list of choices: **Fahrenheit** or **Celsius**.
- When the desired setting is reached, press the **Enter Key** to lock in the value.





DISPLAY SYMBOL	DISPLAY DESCRIPTION
	SEt/Settings
	Minus (-) /Previous Key
	Temp Units
	Enter Key
	Value Of Temp Units
	Modify Key
	Plus (+) /Next Key

7. MICROPROCESSOR CONTROL (cont'd)





7K - SET DATE & TIME - MENU SYSTEM:

The internal timeclock must be set in order to allow defrost schedule feature to occur at the correct time of day. If the clock is not set, the control assumes the time is 12 a.m. at the time power is supplied to the unit. The hours on a 24-hour timeclock read the following way:

h01 = 1:00 a.m.	h07 = 7:00 a.m.	h13 = 1:00 p.m.	h19 = 7:00 p.m.
h02 = 2:00 a.m.	h08 = 8:00 a.m.	h14 = 2:00 p.m.	h20 = 8:00 p.m.
h03 = 3:00 a.m.	h09 = 9:00 a.m.	h15 = 3:00 p.m.	h21 = 9:00 p.m.
h04 = 4:00 a.m.	h10 = 10:00 a.m.	h16 = 4:00 p.m.	h22 = 10:00 p.m.
h05 = 5:00 a.m.	h11 = 11:00 a.m.	h17 = 5:00 p.m.	h23 = 11:00 p.m.
h06 = 6:00 a.m.	h12 = 12:00 p.m.	h18 = 6:00 p.m.	h24 = 12:00 a.m.

DISPLAY SYMBOL	DISPLAY DESCRIPTION
	Sensor
	Minus Key
	Time Parameter
	Enter Key







- Follow the instructions to enter the technician password and **Sensor** submenu.
- Use the **Minus Key** until the **Time parameter** is displayed.
- Press and hold the **Enter Key** to display the current time in the controller. The Month will be displayed first, followed by the Day and then the Year. The Hours, Minutes and Seconds will be displayed next. Continue to hold the **Enter Key** to display all fields in the Date and Time. The fields are identified by the first character:
 - o Month
 - o Day
 - o Year
 - o Hours
 - o Minutes
 - o Seconds

DISPLAY SYMBOL	DISPLAY DESCRIPTION
	Modify Key
	Plus Key
	Minus Key
	Enter Key

- Press the **Modify Key** and the Months field will flash, indicating it is being modified.
- To change a particular Date/Time field, press the **Plus Key** or the **Minus Key** to set the field to the desired value.
- When a Date/Time field is acceptable, press the **Enter Key** to use the value.
- You must step through all six Date/Time fields to change any one field.

7L - SET DAYLIGHT SAVINGS - MENU SYSTEM:

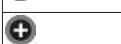
This parameter is used to adjust the 24-hour clock for Daylight Savings Time. Daylight Savings does not automatically adjust and must be set manually. The keypad must be unlocked to access the menu system.



DISPLAY SYMBOL	DISPLAY DESCRIPTION
	SEt/Settings
	Minus (-) /Previous Key
	Enter Key
	Modify Key
	Plus (+) /Next Key
	Daylight Savings Time
	Daylight Standard Time

- Follow the instructions to enter the technician password and **Settings** submenu.
- Use the **Minus Key** until the Daylight Savings Time Flag is displayed.
- Press the **Enter Key** to display the value of the Daylight Savings **Time Flag**.
- Press the **Modify Key** and the value will flash, indicating it is being modified
- To change the temperature units, press the **Plus Key** to step through the list of choices: **daylight savings time** or **daylight standard time**.
- When the desired setting is reached, press the **Enter Key** to lock in the value.

7. MICROPROCESSOR CONTROL (cont'd)

7M - START A DEFROST - MENU SYSTEM:

Defrost can be initiated from the Menu System. Defrost can also be initiated from the Menu System using the short cut (see section below). The keypad must be unlocked to access the menu system.





DISPLAY SYMBOL	DISPLAY DESCRIPTION
	Defrost Submenu
	Enter Key
	Defrost Symbol

- Follow the instructions to enter the customer password and **Defrost submenu**.
- Press the **Enter Key** to start the defrost operation.
- The **Defrost Symbol** will illuminate letting you know defrost is in effect.
- Depending on the settings, the unit may also show “**dEF**” (see below).









7N - SET DEFROST MODE - MENU SYSTEM:

The Defrost Mode is used to configure the way in which the controller determines when to defrost. The possible settings are:

DISPLAY SYMBOL	DISPLAY DESCRIPTION
	Optimize
	Time
	Schedule
	Count

- **Optimize** – Defrost based on the ambient conditions (temp & rH)
- **Time** – Defrost every X hours (fixed interval)
- **Schedule** – Defrost at specific times
- **Count** – Defrost every X compressor cycles

Note 1: The user assumes full responsibility for properly configuring the defrost operation when using the Defrost Schedule feature. The keypad must be unlocked to access the menu system.

DISPLAY SYMBOL	DISPLAY DESCRIPTION
	SEt/Settings
	Minus (-) /Previous Key
	dFo/Defrost Mode
	Enter Key
	Modify Key
	Plus (+) /Next Key

- Follow the instructions to enter the technician password and **Settings** submenu.
- Use the **Minus Key** until the **Defrost Mode** parameter is displayed.
- Press the **Enter Key** to display the value of the **Defrost Mode** parameter.
- Press the **Modify Key** and the value will flash, indicating it is being modified.
- To change the **Defrost Mode**, press the **Plus Key** to step through the list of choices: **Optimize, Time, Schedule or Count** (see above).
- When the desired setting is reached, press the **Enter Key** to lock in the value.

7O - SET DEFROST SCHEDULE - MENU SYSTEM:

The Defrost Schedule parameters allow the customer to configure the controller to defrost the unit at specific times. Customers can set up to six defrost times. They are all programmed the same way. The parameters set the time the defrost is to start. The options are similar to the 24-hour clock settings. **Note 1:** the user assumes full responsibility for properly configuring the defrost operation when using the Defrost Schedule feature. **Note 2:** The 24-hour clock must be set for this feature to operate at the correct time of day. See “**Set Date & Time**” on page 11. **Note 3:** The Defrost Mode must be set to “Schedule” to use the Defrost Schedule feature. See “**Set Defrost Mode**” on page 12. The keypad must be unlocked to access the menu system.

7. MICROPROCESSOR CONTROL (cont'd)

70 - SET DEFROST SCHEDULE - MENU SYSTEM: (cont'd)

DISPLAY SYMBOL	DISPLAY DESCRIPTION
	SEt/Settings
	Plus (+) /Next Key
	Defrost Time 1
	Enter Key
	Hours (value of defrost time)

- Follow the instructions to enter the technician password and **Settings** submenu.
- Use the **Plus Key** until the **Defrost Time 1** is displayed.
- Press and hold the **Enter Key** to display the **value of the defrost time** in the controller. The Hours will be displayed first, followed by the Minutes and then the Seconds. Continue to hold the **Enter Key** to display all fields in the Date and Time. The fields are identified by the first character:

- o Hours
- o Minutes
- o Seconds

DISPLAY SYMBOL	DISPLAY DESCRIPTION
	Hours
	Minutes
	Seconds

DISPLAY SYMBOL	DISPLAY DESCRIPTION
	Modify Key
	Plus (+) /Next Key
	Minus (-) /Previous Key
	Enter Key

- Press the **Modify Key** and the Hours field will flash, indicating it is being modified.
- To change a particular Time field, press the **Plus Key** or the **Minus Key** to set the field to the desired value.
- When a Time field is acceptable, press the **Enter Key** to use the value.
- You must step through all three Time fields to change any one field.
- When the desired setting is reached, press the **Enter Key** to lock in the value.
- Use the **Plus Key** until the Defrost Time 2 is displayed .
- Repeat the steps to program Defrost 2 – Defrost 6

A time of 00:00:00 disables the defrost time (it is not used). To program midnight, enter 24:00:00. The Defrost Times 1 – 6 can be entered in any order. As few as one or as many as six Defrost Times may be entered.

7P - VIEW THE SENSOR TEMPERATURES - MENU SYSTEM:

These parameters allow a service technician or customer to view the temperatures of all sensors within the unit. The temperatures cannot be adjusted. The keypad must be unlocked to access the menu system.

- Follow the instructions to enter the customer password and **Sensors** submenu.
- Press the **Enter Key** to enter the **Sensors** submenu.
- The first parameter displayed will be the **Cabinet Temp** (TC = TempCab).
- Press the **Enter Key** to display the value of the **Cabinet Temp**.
- Use the **Plus Key** to move to the next parameter (**Evaporator Temp**).
- Press the **Enter Key** to display the value of the **Evaporator Temp**.
- Use the **Plus Key** to move through the sensor parameters. The following parameters are available:

DISPLAY SYMBOL	DISPLAY DESCRIPTION
	Cabinet Temp
	Evaporator Temp
	Liquid Line Temp
	Dew Point
	Compressor Command
	Evaporator Fan Command
	Condenser Fan Command
	Defrost Heater Command
	Door Heater Command
	Door Switch Status
	Aux Device Command
	Light Command

- o Cabinet Temp
- o Evaporator Temp
- o Liquid Line Temp
- o Dew Point
- o Compressor Command
- o Evaporator Fan Command
- o Condenser Fan Command
- o Defrost Heater Command
- o Door Heater Command
- o Door Switch Status
- o Aux Device Command
- o Light Command



DISPLAY SYMBOL	DISPLAY DESCRIPTION
	Plus (+) /Next Key
	Minus (-) /Previous Key
	Enter Key

In General:

- Use the **Plus Key** and the **Minus Key** to move through the Menu System.
- Press the **Enter Key** to display the value of the selected parameter.

7. MICROPROCESSOR CONTROL (cont'd)

7Q - HOT FOOD - UNLOCKING THE KEYPAD:

DISPLAY SYMBOL	DISPLAY DESCRIPTION
	Unlock Key
	Keypad Unlock LED

Normally, the keypad is locked to prevent inadvertent changes to settings. The **Unlock Key** is a white dot on the right side of the display, centered between the other 4 keys.





- Press the **Unlock Key** twice within a second in order to unlock the keypad (think “tap-tap”).
- The **Keypad Unlock LED** will turn on to indicate the keypad is now live.

The keypad lock is different from the menu password. The keypad is locked to prevent accidental changes. Once the keypad is unlocked, it is possible to access the menu system. The menu system is password protected. It is necessary to enter a password in order to view or modify parameters.

The keypad will stay unlocked until there is 3 minutes of inactivity, at which time the controller will automatically lock the keypad.

7R - HOT FOOD - ADJUST THE SETPOINT - MENU SYSTEM:

This parameter sets the desired cabinet temperature. Please note that hot food units are delivered from the factory set to the ON position. This parameter is preset at the factory to 145 °F and should set to meet the customer’s requirements. The setpoint for the unit can be changed from the Menu System. There will be a minimum and maximum value allowed for the set point. The keypad must be unlocked to access the menu system.







DISPLAY SYMBOL	DISPLAY DESCRIPTION
	SET/Settings
	Enter Key
	Modify Key
	Plus (+) /Next Key
	Minus (-) /Previous Key

- Follow the instructions to enter the customer password and **Settings submenu**.
- Press the **Enter Key** to enter the **Settings submenu**.
- Use the **Plus Key** until the **Setpoint parameter** is displayed.
- Press the **Enter Key** to display the value of the setpoint .
- Press the **Modify Key** and the value will flash, indicating it is being modified
- To raise the setpoint, press the **Plus Key** to increment to the set point.
Press the **Minus Key** to lower the setpoint.
- When the desired value is reached, press the **Enter Key** to lock in the value.

7S - HOT FOOD - CHANGE THE TEMPERATURE SET POINT (SHORT CUT):





The simplest way to change the temperature set point is using the short cut from the Main Display. The set point can also be configured from the Menu System (see page 10). The setpoint to the unit can be changed by pressing and holding the **Plus Key** or the **Minus Key**. Their will be a slight delay at first to prevent an accidental change, so it will be necessary to hold the key for 2 – 3 seconds until the value starts to flash. The flashing value indicates the setting is being modified.

The keypad must be unlocked in order to change the setpoint using the shortcut method.

DISPLAY SYMBOL	DISPLAY DESCRIPTION
	Plus (+) /Next Key
	Minus (-) /Previous Key
	Unlock Key
	Keypad Unlock LED
	Enter Key
	ESC Key

- Press the **Unlock Key** twice within a second in order to unlock the keypad (think “tap-tap”).
- The **Keypad Unlock LED** will turn on to indicate the keypad is now live.
- To raise the setpoint, press and hold the **Plus Key** to increment to the set point.
Press the **Minus Key** to lower the setpoint.
- The value on the display will flash.
- When the desired value is reached, press the **Enter Key** to lock in the value.
- Pressing the **Esc Key** at any step will abort the process (before the **Enter Key** is pressed).

7T - HOT FOOD - TURN THE UNIT OFF:

DISPLAY SYMBOL	DISPLAY DESCRIPTION
	Unlock Key
	Keypad Unlock LED
	oFF
	Temperature

After the temperature has been set, the customer can continuously turn the unit OFF and then back ON to the same temperature. The keypad must be unlocked in order to de-activate the hot food unit.

- Press the **Unlock Key** twice within a second in order to unlock the keypad (think “tap-tap”).
- The **Keypad Unlock LED** will turn on to indicate the keypad is now live.
- Press and hold the **Unlock Key** until the display shows “**oFF**”.
- To turn the unit ON, press the **Unlock Key** until the display shows the **temperature**.

8. SPARE & REPLACEMENT PARTS LISTING

ITEM/DESCRIPTION	G100/G110 1 SEC REF	G120XX 1 SEC FZR	G200/G210 2 SEC REF	G220XX 2 SEC FZR	G300/G320 3 SEC REF	G313XX/G310XX 3 SEC FZR
DOORS						
Full Height Glass Door	200-60954-01	call factory	all models	not available	all models	not available
Half Hight Glass Door	200-60953-00	call factory	all models	not available	all models	not available
Half Height Glass Door	200-60953-01	call factory	all models	not available	all models	not available
GASKETS						
Full Height Door	SVC-60256-00	all models	all models	all models	all models	all models
Half Height Door	SVC-60257-00	all models	all models	all models	all models	all models
Note: Same Gaskets on both solid and glass doors						
LOCK						
Lockkeeper	358-60707-00	all models	all models	all models	all models	all models
Lock Cylinder	358-13186-42	all models	all models	all models	all models	all models
Lock Cylinder Assy with Key	SER-13186-42	all models	all models	all models	all models	all models
SHELVES/TRAY SLIDES						
Epoxy Coated Shelf (with Pins & Clips)	G1ACC-SHLF5	G1ACC-SHLF5	LFT SEC: G23ACC-SHLF9 RHT SEC: G23ACC-SHLF11	LFT SEC: G23ACC-SHLF9 RHT SEC: G23ACC-SHLF11	LFT SEC: G23ACC-SHLF9 CEN SEC: G3ACC-SHLF15 RHT SEC: G23ACC-SHLF11	LFT SEC: G23ACC-SHLF9 CEN SEC: G3ACC-SHLF15 RHT SEC: G23ACC-SHLF11
Shelf Pin	358-24759-02	all models	all models	all models	all models	all models
3 Epoxy Coated Shelves (with Pins)	G1ACC-SHLF3	G1ACC-SHLF3	LFT SEC: G23ACC-SHLF1 RHT SEC: G23ACC-SHLF5	LFT SEC: G23ACC-SHLF1 RHT SEC: G23ACC-SHLF5	LFT SEC: G23ACC-SHLF1 CEN SEC: G3ACC-SHLF5 RHT SEC: G23ACC-SHLF5	LFT SEC: G23ACC-SHLF1 CEN SEC: G3ACC-SHLF5 RHT SEC: G23ACC-SHLF5
3 Epoxy Coated Shelves (with Pilasters & Clips)	G1ACC-SHLF2	G1ACC-SHLF2	LFT SEC: G23ACC-SHLF2 RHT SEC: G23ACC-SHLF6	LFT SEC: G23ACC-SHLF2 RHT SEC: G23ACC-SHLF6	LFT SEC: G23ACC-SHLF2 CEN SEC: G3ACC-SHLF6 RHT SEC: G23ACC-SHLF6	LFT SEC: G23ACC-SHLF2 CEN SEC: G3ACC-SHLF6 RHT SEC: G23ACC-SHLF6
3 Plated Shelves (With Pins)	G1ACC-SHLF3	G1ACC-SHLF3	LFT SEC: G23ACC-SHLF3 RHT SEC: G23ACC-SHLF7	LFT SEC: G23ACC-SHLF3 RHT SEC: G23ACC-SHLF7	LFT SEC: G23ACC-SHLF3 CEN SEC: G3ACC-SHLF7 RHT SEC: G23ACC-SHLF7	LFT SEC: G23ACC-SHLF3 CEN SEC: G3ACC-SHLF7 RHT SEC: G23ACC-SHLF7
3 Plated Shelves (with Pilasters & Clips)	G1ACC-SHLF4	G1ACC-SHLF4	LFT SEC: G23ACC-SHLF4 RHT SEC: G23ACC-SHLF8	LFT SEC: G23ACC-SHLF4 RHT SEC: G23ACC-SHLF8	LFT SEC: G23ACC-SHLF4 CEN SEC: G3ACC-SHLF8 RHT SEC: G23ACC-SHLF8	LFT SEC: G23ACC-SHLF4 CEN SEC: G3ACC-SHLF8 RHT SEC: G23ACC-SHLF8
#1 Tray Slides - 8 Pairs (with Pilasters)	G1ACC-TK1	G1ACC-TK1	LFT/RHT SEC: G23ACC-TK1LR	LFT/RHT SEC: G23ACC-TK1LR	LFT/RHT SEC: G23ACC-TK1LR CEN SEC: G3ACC-TK1C	LFT/RHT SEC: G23ACC-TK1LR CEN SEC: G3ACC-TK1C
#4 Tray Slides - 2 Pair (with Pilasters)	G1ACC-TK2	G1ACC-TK2	LFT/RHT SEC: G23ACC-TK2LR	LFT/RHT SEC: G23ACC-TK2LR	LFT/RHT SEC: G23ACC-TK2LR CEN SEC: G3ACC-TK2C	LFT/RHT SEC: G23ACC-TK2LR CEN SEC: G3ACC-TK2C
Universal Tray Slides - 7 Pairs (with Pilasters)	G1ACC-TK4	G1ACC-TK4	LFT/RHT SEC: G23ACC-TK4LR	LFT/RHT SEC: G23ACC-TK4LR	LFT/RHT SEC: G23ACC-TK4LR CEN SEC: G3ACC-TK4C	LFT/RHT SEC: G23ACC-TK4LR CEN SEC: G3ACC-TK4C
LEGS/CASTERS						
Legs 6" high (set of 4)	LK1	all models	all models	all models	all models	all models
LOUVER ASSY	SK-500-60827-00	SK-500-60827-00	SK-500-60827-02	SK-500-60827-02	SK-500-60827-03	SK-500-60827-03
SENSORS						
Cabinet Sensor	334-60083-01	334-60083-01	334-60083-02	334-60083-02	334-60083-03	G313: 334-60083-03 G310: 334-60405-02
Coil Sensor	334-60084-01	334-60084-01	334-60084-02	334-60084-02	334-60084-03	G313: 334-60084-03 G310: 334-60406-02
LIGHT						
Light Buld - LED	358-60691-00	all models	all models	all models	all models	all models
EVAPORATOR						
Expansion Valve	325-60080-37	325-60080-25	325-60080-37	325-60080-26	325-60080-38	325-60080-34
Evaporator Motor Assy (Sheetmetal Box and Fan Assy)	SK-600-61081-00	SK-600-61081-00	SK-600-61081-00	SK-600-61081-01	SK-600-61081-01	SK-600-61081-01
Evaporator Motor Assy (Motor And Blade Assy)	338-60061-00	all models	all models	all models	all models	all models
Note: Fan blade and motor bracket are no longer needed						
Exterior Light Switch	337-20265-00	not available	337-20265-00	not available	337-20265-00	not available
Hot Gass Loop	315-60307-00	315-60307-00	315-60307-00	315-60310-00	G300: 315-60310-00 G320: 315-10041-02	315-10041-02
Relay	call factory	call factory	call factory	call factory	call factory	call factory
Start Capacitor	call factory	call factory	call factory	call factory	call factory	call factory

9. TROUBLE SHOOTING GUIDE

FIND YOUR PROBLEM HERE	REMEDY
1. Condensing unit fails to start.	<ul style="list-style-type: none"> a. Check if cord & plug has been disconnected. b. Check control temperature setting.
2. Condensing unit operates for prolonged periods or continuously.	<ul style="list-style-type: none"> a. Are doors closing properly? b. Dirty condenser or filter. Clean properly. c. Evaporator coil iced. Needs to defrost. See instructions for setting a manual defrost cycle on page 13.
3. Food compartment is too warm.	<ul style="list-style-type: none"> a. Check door(s) and gasket(s) for proper seal b. Perhaps a large quantity of warm food has recently been added or the door was kept open for a long period of time, in both cases, allow adequate time for the cabinet to recover its normal operating temperature. c. Control setting too high, readjust per instructions on page 10. d. Check that condensing coil is clean.
4. Food compartment is too cold.	<ul style="list-style-type: none"> a. Perhaps a large quantity of very cold or frozen food has recently been added. Allow adequate time for the cabinet to recover its normal operating temperature. b. Adjust the control to a warmer setting, see page 10.
5. Condensation on the exterior surface.	<ul style="list-style-type: none"> a. Check door alignment and gaskets for proper seal. b. Condensation on the exterior surface of the unit is perfectly normal during periods of high humidity.
6. Compressor hums but does not start.	<ul style="list-style-type: none"> a. Call for service.
7. No Power To Unit	<ul style="list-style-type: none"> a. Check if cord & plug has been disconnected. b. Check power supply breaker. c. Check ON/OFF switch.

10. WARRANTY INFORMATION



TRAULSEN EQUIPMENT WARRANTY



U.S. Domestic Warranty

For sales of Traulsen refrigeration equipment (“Equipment”) within the United States, Traulsen warrants to the original purchaser of the Equipment (“Purchaser”) that Traulsen will convey the Equipment free and clear of all liens, security interests, and encumbrances created by, through or under Traulsen. Traulsen further warrants that for a period of three (3) years from the later of either (a) the date of delivery to the common carrier or (b) the date of installation (the “Domestic Warranty Period”) but in no event, shall the Domestic Warranty Period commence later than 3 months from the date of delivery to the common carrier unless otherwise agreed upon by the parties in writing, under normal use and given proper installation and maintenance as determined by Traulsen, the Equipment: (a) will conform to the specifications as provided by Traulsen (“Specifications”) and (b) will be free from substantial defects in material and workmanship.

The warranty period for compressors shall extend for an additional two (2) years beyond the Domestic Warranty Period. In the case of a nonconforming compressor, Traulsen shall provide a replacement compressor; however, all installation, recharging, and repair costs shall be the responsibility of Purchaser. In the case of a nonconforming part, Purchaser must return the part to Traulsen within 30 days from the date of repair. Failure to return a claimed defective part to Traulsen within the 30 days will waive the right to the warranty claim.

Additionally, Traulsen provides a lifetime warranty on the housing of cam-lift hinges and the workflow handles. In the case of a non-conforming housing for cam-lift hinge or workflow handle, Traulsen shall provide a replacement part; however, Purchaser shall be responsible for any other replacement costs, including but not limited to installation and labor.

The Domestic Warranty does not apply to: (a) consumable components or ordinary wear items; (b) components that are removable without the use of tools including but not limited to gaskets, shelf pins, and light bulbs; (c) use of the Equipment components or parts not supplied by Traulsen or specified by Traulsen in the Operator’s Manual as set forth on Traulsen’s website; or (d) damage resulting from fire, water, burglary, accident, abuse, misuse, transit, acts of God, terrorism, power surges, improper installation, or repairs or installation by unauthorized third parties.

For Traulsen units purchased for use with a condenser provided by a third-party, this standard warranty will apply only to those components contained within the unit to the point of connection of the refrigeration lines leading to the third-party condenser.

In the event of a breach of the warranties set forth above (the “Domestic Warranty”), Traulsen will, at Traulsen’s option and as Purchaser’s sole remedy, repair or replace, including labor costs, any nonconforming Equipment, provided that (a) during the Warranty Period Traulsen is promptly notified in writing upon discovery of the nonconformance with a detailed explanation of any alleged deficiencies; (b) Traulsen is given a reasonable opportunity to investigate all claims; and (c) Traulsen’s examination of any alleged defective part confirms such alleged deficiencies and that the deficiencies were not caused by misuse, neglect, improper installation, unauthorized alteration or repair or improper testing. Traulsen reserves the right to, at its request, require Purchaser shall ship the alleged defective part to Traulsen for inspection and confirmation of defect. No Equipment may be returned without Traulsen’s approval.

Purchaser is solely responsible for determining if Equipment is fit for a particular purpose and suitable for Purchaser’s application. Accordingly, and due to the nature and manner of Traulsen’s Equipment, Traulsen is not responsible for the results or consequences of use, misuse, or application of its Equipment.

THIS DOMESTIC WARRANTY SETS FORTH THE EXTENT OF TRAULSEN’S LIABILITY FOR SALES WITHIN THE UNITED STATES. EXCEPT AS SET FORTH ABOVE, TRAULSEN MAKES NO WARRANTY OR REPRESENTATION OF ANY KIND, EXPRESS OR IMPLIED (INCLUDING NO WARRANTY OF MERCHANTABILITY OR FITNESS FOR ANY PARTICULAR PURPOSE). IN NO EVENT WILL TRAULSEN’S LIABILITY IN CONNECTION WITH THE AGREEMENT OR SALE OF THE EQUIPMENT EXCEED THE PURCHASE PRICE OF THE EQUIPMENT AS TO WHICH THE CLAIM IS MADE. IN NO EVENT SHALL TRAULSEN BE LIABLE FOR ANY LOSS OF USE, LOSS OF PRODUCT, LOSS OF PROFIT, OR ANY OTHER INDIRECT, INCIDENTAL, SPECIAL, OR CONSEQUENTIAL DAMAGES RESULTING FROM THIS WARRANTY EVEN IF TRAULSEN HAS BEEN NOTIFIED OF THE POSSIBILITY OF SUCH DAMAGES.



TRAULSEN
4401 BLUE MOUND RD.
PHONE 1 (800) 825 8220
Website: www.traulsen.com

FT. WORTH, TX 76106
FAX-MKTG. 1 (817) 624 4302

10. WARRANTY INFORMATION (cont'd)



TRAULSEN EQUIPMENT WARRANTY

Export Warranty

For sales of Traulsen refrigeration equipment ("Equipment") outside of the United States, Traulsen warrants parts only, not labor to the original purchaser of the Equipment ("Purchaser") that Traulsen will convey the Equipment free and clear of all liens, security interests and encumbrances created by, through or under Traulsen. Traulsen further warrants that for a period of one (1) year from the date of delivery to the common carrier (the "Export Warranty Period") unless otherwise agreed upon by the parties in writing, under normal use and given proper installation and maintenance as determined by Traulsen, the Equipment: (a) will conform to the Specifications as provided by Traulsen; and (b) will be free from substantial defects in material and workmanship. It is the end user's responsibility to arrange for the export shipping.

The Export Warranty does not apply to: (a) consumable components or ordinary wear items; (b) components that are removable without the use of tools including but not limited to gaskets, shelf pins, and light bulbs; (c) use of the Equipment components or parts not supplied by Traulsen or specified in the Operator's Manual as set forth on Traulsen's website; or (d) damage resulting from fire, water, burglary, accident, abuse, misuse, transit, acts of God, terrorism, power surges, improper installation, or repairs or installation by unauthorized third parties.

For Traulsen units purchased with a condenser provided by a third-party other than Traulsen, this standard warranty will apply only to those components contained within the unit to the point of connection of the refrigeration lines leading to the to the third-party condenser.

In the event of a breach of the warranties set forth above (the "Export Warranty"), Traulsen will, at Traulsen's option and as Purchaser's sole remedy, repair or replace, but not including labor, freight, export costs, packaging costs, any nonconforming Equipment, provided that (a) during the Export Warranty Period Traulsen is promptly notified in writing upon discovery of such nonconformance with a detailed explanation of any alleged deficiencies; (b) Traulsen is given a reasonable opportunity to investigate all claims; and (c) Traulsen's examination of such piece of Equipment defective part confirms the alleged nonconformity and that the nonconformities were not caused by misuse, neglect, improper installation, unauthorized alteration or repair or improper testing. Traulsen reserves the right to, at its request, require Purchaser shall ship the alleged defective part to Traulsen for inspection and confirmation of defect. No Equipment may be returned without Traulsen's approval.

Purchaser is solely responsible for determining if Equipment is fit for a purpose and suitable for Purchaser's application. Accordingly, and due to the nature and manner of Traulsen's Equipment, Traulsen is not responsible for the results or consequences of use, misuse, or application of its Equipment.

THIS EXPORT WARRANTY SETS FORTH THE EXTENT OF TRAULSEN'S LIABILITY FOR SALES OUTSIDE THE UNITED STATES. EXCEPT AS SET FORTH ABOVE, TRAULSEN MAKES NO WARRANTY OR REPRESENTATION OF ANY KIND, EXPRESS OR IMPLIED (INCLUDING NO WARRANTY OF MERCHANTABILITY OR FITNESS FOR ANY PARTICULAR PURPOSE). IN NO EVENT WILL TRAULSEN'S LIABILITY IN CONNECTION WITH THE AGREEMENT OR SALE OF THE EQUIPMENT EXCEED THE PURCHASE PRICE OF THE EQUIPMENT AS TO WHICH THE CLAIM IS MADE. IN NO EVENT SHALL TRAULSEN BE LIABLE FOR ANY LOSS OF USE, LOSS OF PRODUCT, LOSS OF PROFIT, OR ANY OTHER INDIRECT, INCIDENTAL, SPECIAL, OR CONSEQUENTIAL DAMAGES RESULTING FROM THIS WARRANTY EVEN IF TRAULSEN HAS BEEN NOTIFIED OF THE POSSIBILITY OF SUCH DAMAGES.



TRAULSEN
4401 BLUE MOUND RD.
PHONE 1 (800) 825 8220
Website: www.traulsen.com

FT. WORTH, TX 76106
FAX-MKTG. 1 (817) 624 4302



Quality Refrigeration

4401 Blue Mound Road Fort Worth, Texas 76106 (USA)

Phone: 800.825.8220 | Service Fax: 817.740.6757 | E-mail: service@traulsen.com | Website: traulsen.com

Form Number: TR35748 | Part Number: 375-60184-00 | Revision Date: 01-03-18

Traulsen © All Rights Reserved